



**Technical Service
BULLETIN**

February 4, 2004

Title:

ZERO POINT CALIBRATION

Models:

'04 – '05 4Runner, Camry, Highlander,
Land Cruiser, RAV4, Sienna, Solara, Tundra,
& Scion xB with VSC

REVISED
BR001-04
BRAKES

TSB REVISION NOTICE:

- **March 7, 2006:** 2005 model year has been added to Applicable Vehicles. The Required SSTs table has been updated to the current software. The screen flows in step 2 of the "Calibration Procedure With Diagnostic Tester" section have been updated.
- **February 16, 2004:** Calibration Procedure clarified on page 2 (step 2) and page 4 (step 1).

Previous versions of this TSB should be discarded.

Introduction The following information is intended to clarify the repair manual procedures for Zero Point Calibration and sensor checks after the replacement of any of the following components.

- Vehicle Stability Control Computer
- Steering Angle Sensor
- Yaw Rate Sensor
- Deceleration Sensor

Zero point calibration of the above sensors must also be performed when replacing or repairing steering related parts. These steps are necessary for the correct and accurate repair of VSC related systems.



- Applicable Vehicles**
- **2004 – 2005** model year 4Runner, Camry, Highlander, Land Cruiser, RAV4, Sienna, Solara, Tundra, and Scion xB vehicles equipped with VSC.

Warranty Information

OP CODE	DESCRIPTION	TIME	OFF	T1	T2
N/A	Not Applicable to Warranty	–	–	–	–



Required SSTs

ITEM NO.	SPECIAL SERVICE TOOLS (SSTs)	PART NUMBER	QTY	DRW**
1	<p>Toyota Diagnostic Tester Kit*</p> <p>NOTE:</p> <ul style="list-style-type: none"> All components from this kit/set are needed 12 Megabyte Diagnostic Tester Program Card (P/N 01002593-005) with version 13.3a Software (or later) is needed 	TOY220036	1	9
2	<p>CAN Interface Module Kit*</p> <p>NOTE: All components from this kit/set are needed</p> 	01002744	1	9
3	<p>Diagnostic Check Wire*</p> 	09843-18040	1	18

* Essential SSTs.

** Refers to drawer number in SST Storage System.

NOTE:

Additional Diagnostic Tester Kits, CAN Interface Modules, Program Cards, or other SSTs may be ordered by calling SPX/OTC at 1-800-933-8335.

Calibration Procedure With Diagnostic Tester

Zero Point Calibration Procedure Using Diagnostic Tester

1. Connect Diagnostic Tester to DLC3.

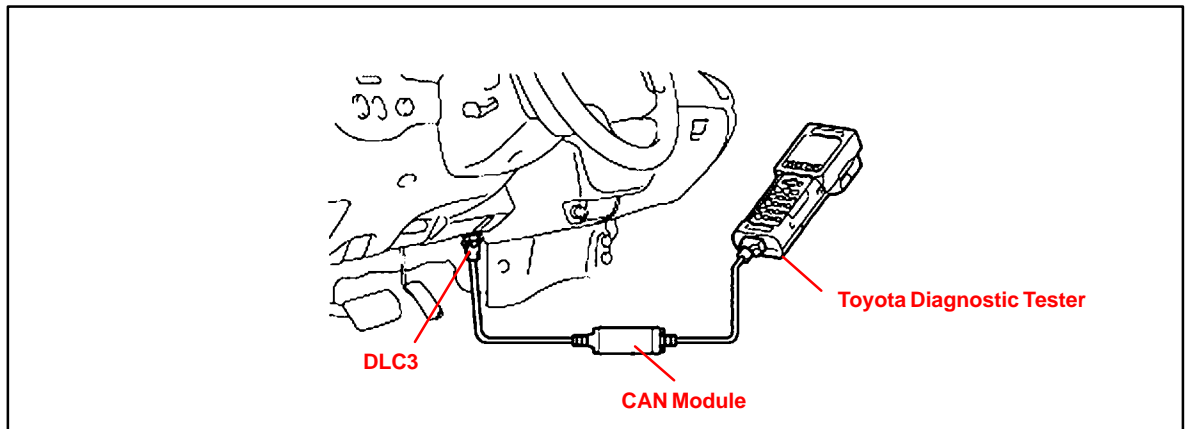

2. Follow the flow below for the calibration procedure. If the vehicle is equipped with automatic transmission (A/T), ensure that the shift lever is in the “P” range and the parking brake is applied. If the vehicle is equipped with manual transmission (M/T), ensure that the parking brake is applied.

NOTE:
 While performing the Zero Point Calibration, do NOT tilt, move, or shake the vehicle. The vehicle must remain in a stationary condition throughout the entire process. Be sure to perform the procedure on a level surface with an inclination of less than 1%.

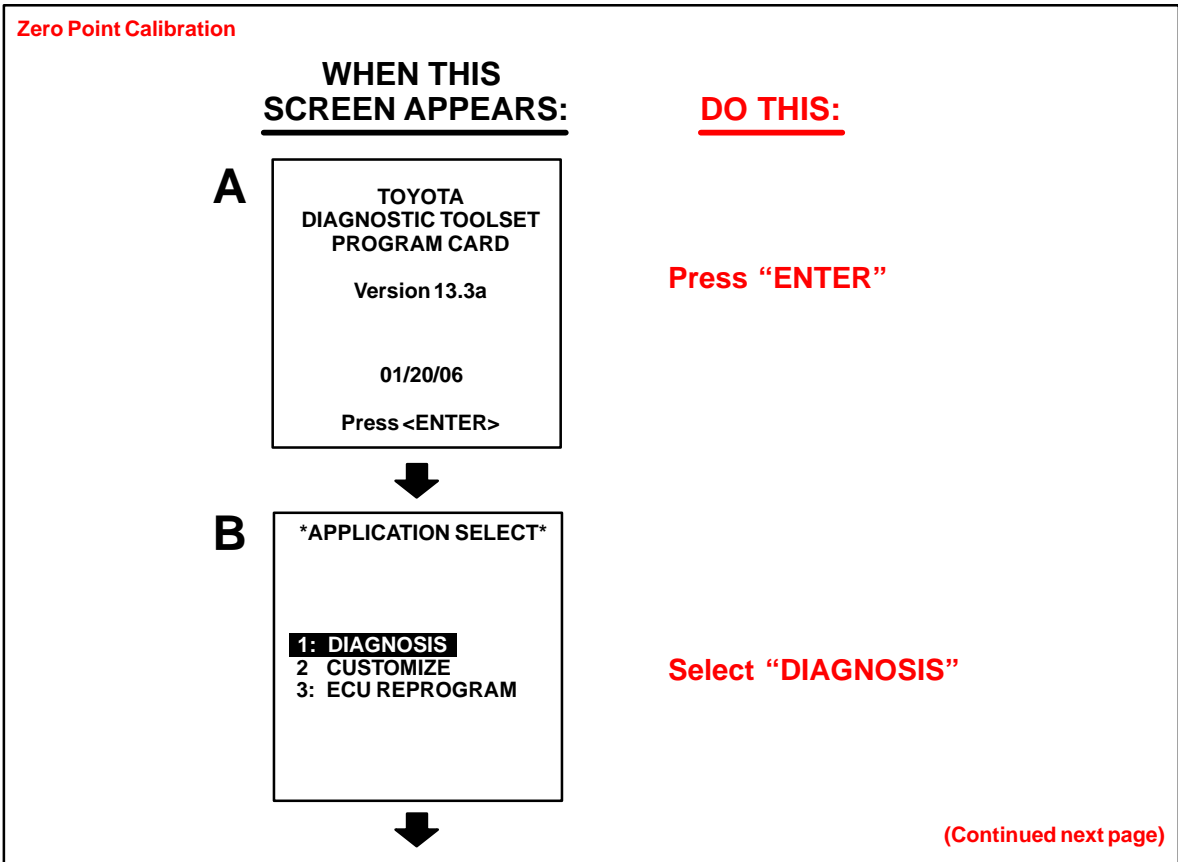

Repair Procedure
(Continued)

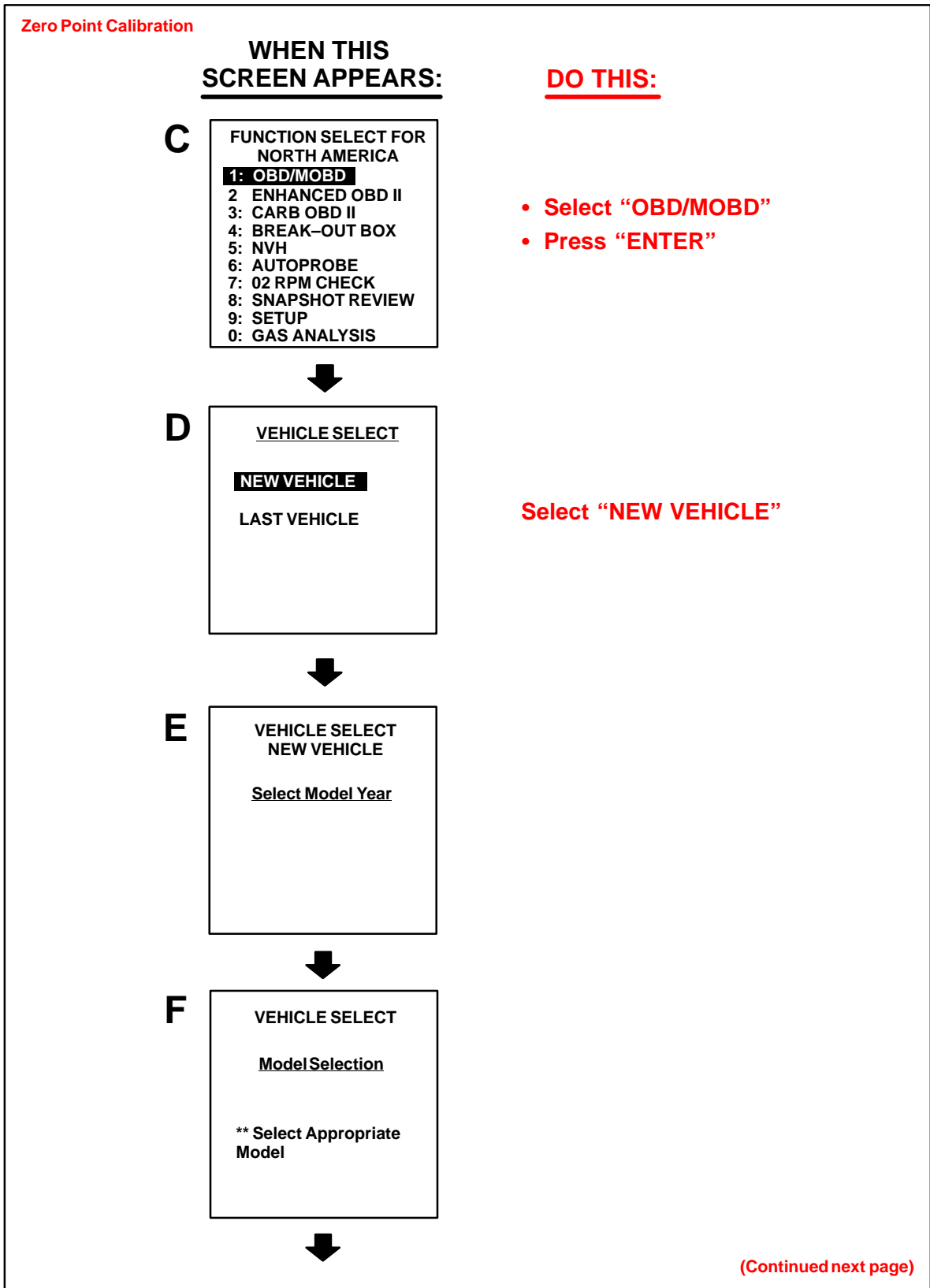

Repair Procedure
(Continued)

Zero Point Calibration (Continued)

WHEN THIS SCREEN APPEARS:

DO THIS:

G

OBD/MOBD MENU

- 1: CODES (ALL)
- 2: ENGINE AND ECT
- 3: ABS / VSC
- 4: CCS
- 5: IMMOBILIZER
- 6: SRS AIRBAG

- Select “ABS/VSC”
- Press “ENTER”



H

Verify Connections

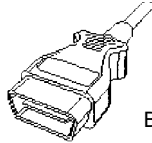

Black

DLC3 Cable
(J1962 Cable)
[YES] to continue

- Press “YES”



I

INITIALIZING CAN
INTERFACE

PLEASE WAIT



J

* WARNING *

This vehicle requires that the engine is idling to communicate w/ the ABS/TR(A)/VSC ECU.

Please ensure that the engine is idling.

PRESS [ENTER]

Press “ENTER”



(Continued next page)

Repair Procedure
(Continued)

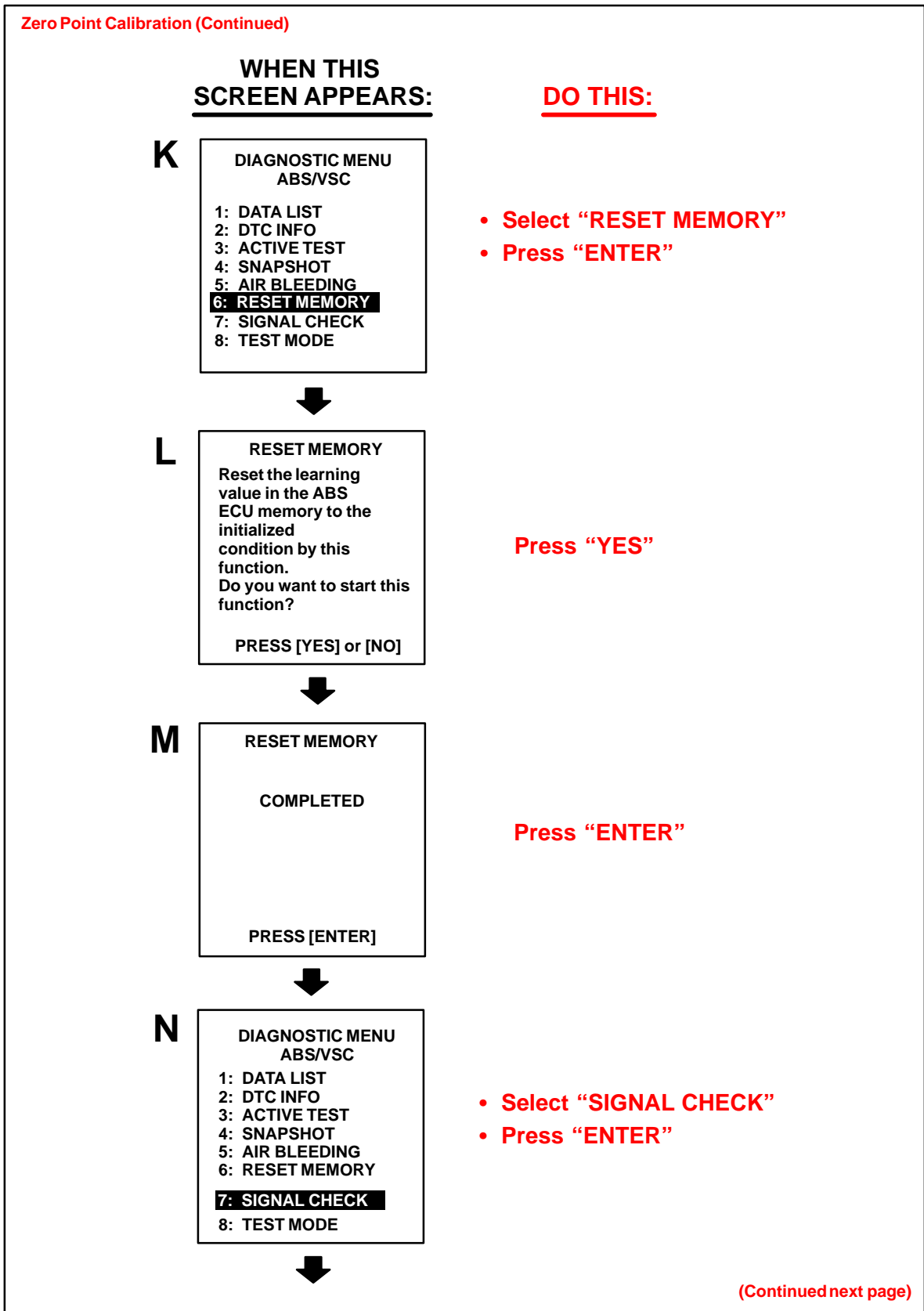

Repair Procedure
(Continued)

Zero Point Calibration (Continued)

	WHEN THIS SCREEN APPEARS:	<u>DO THIS:</u>
O	<p style="text-align: center;">NOTICE</p> <p style="text-align: center;">ALL TROUBLE CODES WILL BE CLEARED AFTER THIS FUNCTION IS SELECTED.</p> <p style="text-align: center;">PRESS [EXIT] TO ABORT SIGNAL CHECK</p> <p style="text-align: center;">PRESS [ENTER] TO CONTINUE</p>	<p style="color: red; font-weight: bold;">Press "ENTER"</p>
P	<p style="text-align: center;">CHECK PROCEDURE</p> <p style="text-align: center;">PERFORM CHECK OPERATION ON VEHICLE ACCORDING TO REPAIR MANUAL.*</p> <p style="text-align: center;">PRESS [ENTER] WHEN OPERATION COMPLETED</p> <p style="text-align: center;">PRESS [EXIT] TO QUIT SIGNAL CHECK</p>	<p style="color: red; font-weight: bold;">Select EXIT when VSC/TRAC and ABS lights begin to flash at 0.13 second intervals.</p> <div style="border: 1px solid red; padding: 5px; margin-top: 10px;"> <p style="color: red; font-weight: bold;">*NOTE:</p> <p style="color: black; font-weight: bold;">It is NOT necessary to perform any repair manual procedures at this step.</p> </div>
Q	<p style="text-align: center;">CONFIRM EXIT</p> <p style="text-align: center;">NOTE: WHEN EXITING FUNCTION, ALL STORED TROUBLE CODES WILL BE CLEARED.</p> <p style="text-align: center;">Do you wish to EXIT?</p> <p style="text-align: center;">PRESS [YES] or [NO]</p>	<p style="color: red; font-weight: bold;">Press "YES"</p>

3. Drive the vehicle for **at least 5 minutes** to confirm Zero Point Calibration is complete.

NOTE:
If viewing Diagnostic Tester Data List after repair, the Steering Angle Sensor may remain at 1150 until the vehicle reaches 28 mph. This is a normal condition until the learned values of the steering angle have been achieved.

**Calibration
Procedure
With SST****Zero Point Calibration Using SST 09843–18040**

The following procedure may be used in the cases where a Diagnostic Tester is not available.

NOTE:

While performing the Zero Point Calibration, do NOT tilt, move, or shake the vehicle. The vehicle must remain in a stationary condition throughout the entire process. Be sure to perform the procedure on a level surface with an inclination of less than 1%.

1. If the vehicle is equipped with A/T, ensure that the shift lever is in the “P” range and the parking brake is applied. If the vehicle is equipped with a M/T, ensure that the parking brake is applied.
2. Turn the ignition switch ON.
3. Using the SST, repeat a cycle of short and open between terminals Ts and CG of DLC3 4 times or more within 8 seconds (refer to the specific vehicle EWD for TS and CG pin location in the DLC3).
 - **SST 09843–18040**
4. Verify that the VSC indicator light is lit indicating the recorded zero point is erased.
5. Turn the ignition switch OFF.
6. Be sure the terminals Ts and CG of DLC3 are disconnected.
7. Turn the ignition switch ON.
8. Check that the VSC warning light goes off about 15 seconds after the ignition switch is turned ON.
9. After ensuring that the VSC warning light remains OFF for 2 seconds, turn the ignition switch OFF.
10. Connect terminals Ts and CG of DLC3 using the SST.
 - **SST 09843–18040**
11. Turn the ignition switch ON.
12. After turning the ignition switch ON, check that the VSC warning light is lit for about 4 seconds and then starts quick blinking at 0.13 second intervals.
13. After ensuring the blinking of the VSC warning light for 2 seconds, turn the ignition switch OFF.
14. Remove the SST from terminals Ts and CG of DLC3.
15. Drive the vehicle for **at least 5 minutes** to confirm Zero Point Calibration is complete.

NOTE:

If viewing Diagnostic Tester Data List after repair, the Steering Angle Sensor may remain at 1150 until the vehicle reaches 28 mph. This is a normal condition until the learned values of the steering angle have been achieved.