

Service.



Self-Study Program 175

On-Board Diagnosis System II

in the New Beetle (USA)

Design and Function



Far-reaching man-made atmospheric changes are looming on the horizon. They will have grave consequences for the earth's biosphere unless we dramatically reduce and control the pollutant emissions of motor vehicles, among other things.

The On-Board Diagnosis System (or OBD) was introduced for this purpose. OBD is a diagnosis system integrated in the vehicle's engine management system which continuously monitors the components affecting exhaust emissions. If a fault occurs, OBD recognizes it, stores it and indicates it via the self-diagnosis fault warning lamp (MIL).

OBD II is the second generation of engine management systems with diagnosis capability. OBD II offers the following advantages over periodic vehicle checks:

- It checks pollutant emissions continuously,
- indicates malfunctions early, and
- provides full-fledged diagnosis functions which simplify troubleshooting and fault correction for workshop personnel.

In the long term, we will expand the capabilities of the diagnosis system to make it possible to detect faults in the exhaust system that are detrimental to emission behavior by means of a simple OBD reader, even during spot checks.



175_001



Self-Study Program No. 175 was developed and published specially for the U.S. market at that time.

On account of recent developments (launch of US Beetle model onto European market), we have updated this SSP and included it in our Program under No. 175.

NEW



Important Note



The Self-Study Program is not a Workshop Manual!

Please always refer to the relevant Service Literature for all inspection, adjustment and repair instructions. Service literature.

Contents



OBV Variants	4
Overview of OBD-II (Gasoline Engine)	6
System Overview (Gasoline Engine)	20
System Components (Gasoline Engine)	22
Overview of OBD-II (Diesel)	60
System Overview (Diesel)	64
System Components (Diesel)	66
Self-Diagnosis	78
OBD-II (Gasoline Engine)	78
OBD-II (Diesel)	83
Function Diagram	84
2.0-liter Gasoline Engine	84
1.9-liter TDI	86
Test Your Knowledge	88



OBD Variants



The components of the New Beetle (USA) which affect exhaust emissions are monitored on both the gasoline engine and the diesel engine. On account of the different system requirements relating to combustion and exhaust gas treatment, we had to adapt and separate the diagnosis of these systems. The results of this work are the **OBD-II for the gasoline engine** and the **OBD-II for the diesel engine**. Both variants are described separately in this SSP.

Engine variants used in the New Beetle (U.S. model)

The U.S. models of the New Beetle have been delivered with two engine variants:

- Gasoline engine: 2.0-liter four-cylinder (AEG) with OBD-II for the gasoline engine
- Diesel engine: 1.9-liter four-cylinder TDI (ALH/90 bhp) with OBD-II for the diesel



175_025



2.0-liter four-cylinder



175_020

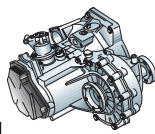

175_021

02J

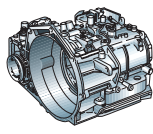

175_022

01M

Gasoline engine monitoring functions

- Catalytic converter function monitor
- Lambda probe aging diagnosis
- Lambda probe voltage test
- Secondary air system
- Fuel vapor retention system
- Leak diagnosis
- Fuel supply system
- Misfiring
- CAN bus
- Motronic control unit
- All sensors and actuators affecting exhaust emissions connected to the control unit

Gasoline engine monitoring functions

- Exhaust gas recirculation
- Misfiring
- Injection commencement control
- Charge pressure control
- Automatic transmission
- CAN bus
- Diesel direct injection system control unit
- All sensors and actuators affecting exhaust emissions connected to the control unit

1,9 l TDI (90 bhp)



175_023

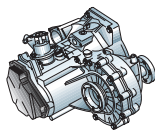

175_021

02J

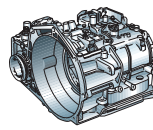

175_022

01M

Overview of OBD-II (Gasoline Engine)

Basic Concept of OBD-II

Since 1970 the California Air Resources Board (CARB) has tried everything within its power to curb atmospheric pollution by imposing statutory requirements.

The concepts which these efforts have spawned, such as OBD-I (1985) for example, have already contributed to a welcome reduction in the emission values of motor vehicles.

History of pollutant emissions in California:

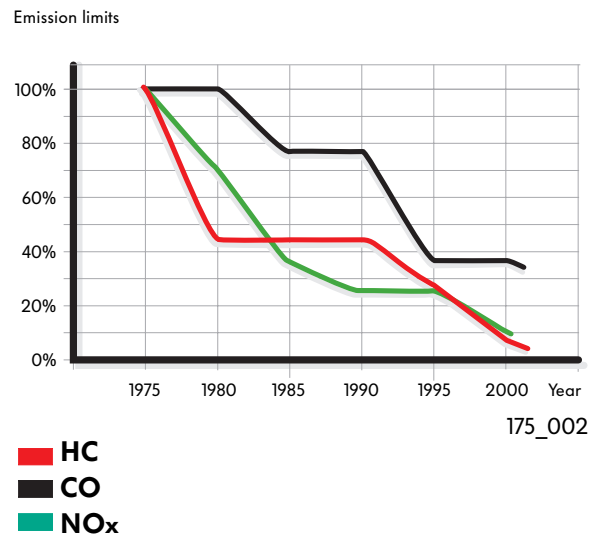

Malfunctions and faulty components in the engine management system can lead to a drastic increase in pollutant emission.

In view of the technical complexity involved, the concentrations of

CO – carbon dioxide
HC– hydrocarbons, and
NO_x – nitrogen oxides

cannot be measured directly. Instead, they are determined by testing the components of the engine management system which affect exhaust emissions.

This also has the advantage that faults can be traced directly by using a Scan Tool.

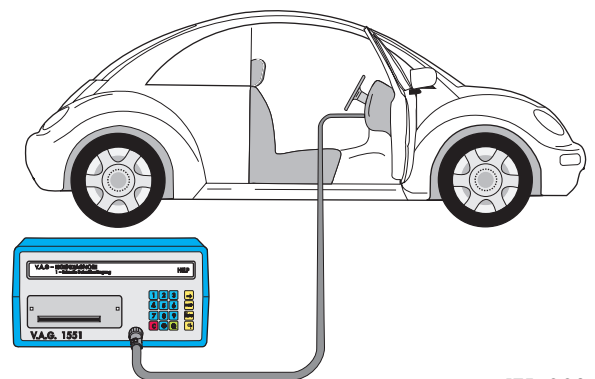

175_003

Requirements:

- Standardized diagnosis plug connection in the driver area
- Standardized fault codes for all manufacturers
- Fault indicated by commercial diagnosis and testing systems
- Indicate the operating conditions in which a fault occurred
- Determine when and how a fault affecting exhaust emissions is indicated
- Standardized names/abbreviations of components and systems



Objective:

- Monitor all parts which are important to emission quality
- Protect the catalytic converter from damage
- Indicate visual alarms when parts affecting exhaust emissions malfunction
- Fault storage
- Diagnosis capability

To reach this objective, the Motronic control unit monitors the following components and systems:

- Catalytic converter
- Lambda probe
- Misfire detection system
- Secondary air system
- Exhaust gas recirculation system
- Fuel tank purging system and leak testing system
- Fuel distribution system
- All sensors and actuators affecting exhaust emissions and connected to the control unit
- Automatic transmission



As the function of the transmission also affects exhaust emission quality, data from the transmission control unit must also be exported during a diagnosis.

Overview of OBD-II (Gasoline Engine)

The OBD II is an improved version of the OBD-I.

OBD-I monitors:

the functional capability of sensors and actuators by measuring the voltage drops across components.

OBD-II monitors:

- all functions of the input and output components such as OBD I, e.g.:
 - short-circuit to positive,
 - short-circuit to ground,
 - open circuit
- signals and components of functions affecting exhaust emissions for plausibility (e.g. catalytic converter, lambda probe)
- system functions (e.g. secondary air system)
- the entire drivetrain (e.g. emergency operation of automatic transmission)

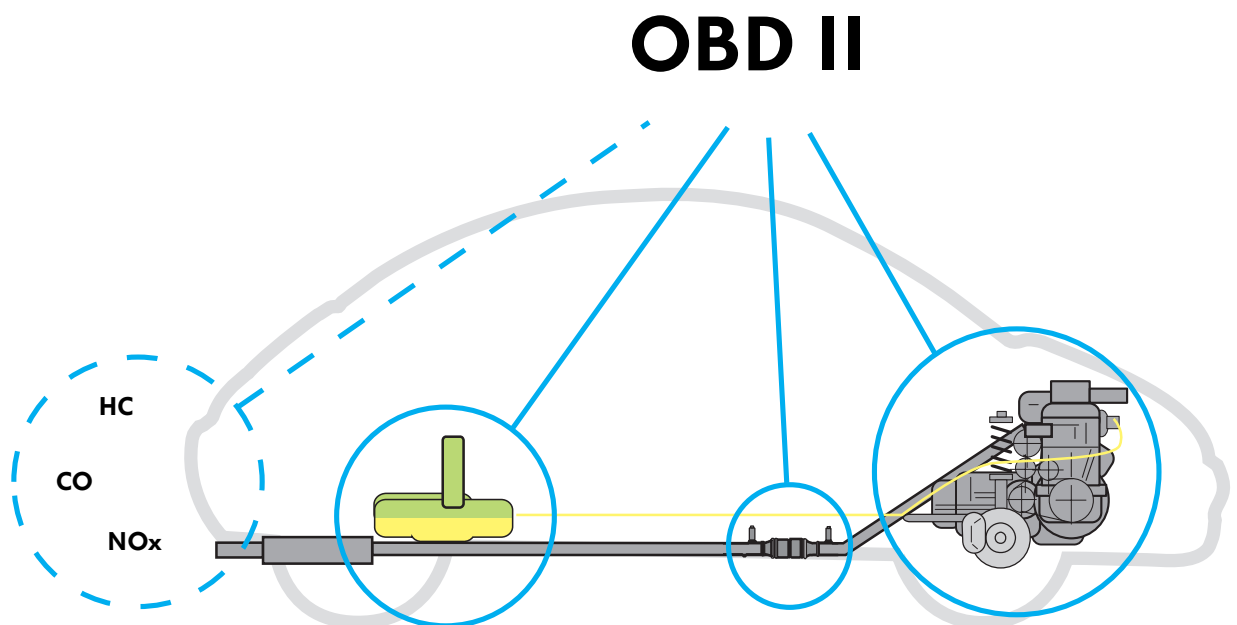

175_004

Glossary:

CARB (California **A**ir **R**esources **B**oard)

SAE (Society of **A**utomotive **E**ngineers)

This society drafts proposals/guidelines for implementing statutory requirements (e.g. standards).

NLEV (**N**on-**L**ow **E**mission **V**ehicles)

Approval level for vehicles which comply with the currently valid requirements (0.25 g/mi HC).

TLEV (**T**ransitional **L**ow **E**mission **V**ehicles)

Approval level for vehicles with low exhaust emission figures (0.125 g/mi HC).

LEV (**L**ow **E**mission **V**ehicles)

Approval level for vehicles which must comply with the new, more stringent requirements (0.075 g/mi HC).

ULEV (**U**ltra **L**ow **E**mission **V**ehicles)

Approval level for vehicles with a further reduction in emission values (0.04 g/mi HC).

SULEV (**S**upra **U**ltra **L**ow **E**mission **V**ehicles)

A further improvement on approval level ULEV.

EZEV (**E**quivalent **Z**ero **E**mission **V**ehicles)

Approval level for vehicles which emit practically no pollutants.

ZEV (**Z**ero **E**mission **V**ehicles)

Approval level for vehicles which emit no pollutants.

Generic Scan Tool

The universal tester to fetch fault messages from fault memory.

ISO 9141-CARB

Standard for data transfer to the reader

Comprehensive Components Monitoring

(also: Comprehensive Components Diagnosis)

Diagnosis system which checks all electrical components and output stages for correct functioning by determining the voltage drop across the component in question.

Driving Cycle

Driving cycle comprising starting the engine, executing the diagnosis function in question and turning off the engine.



Overview of OBD-II (Gasoline Engine)

FTP72 (Federal Test Procedure)

A driving cycle over a distance of 7.5 miles for a time of 1372 s defined for the U.S.A. Max. speed is 91.2 kph.

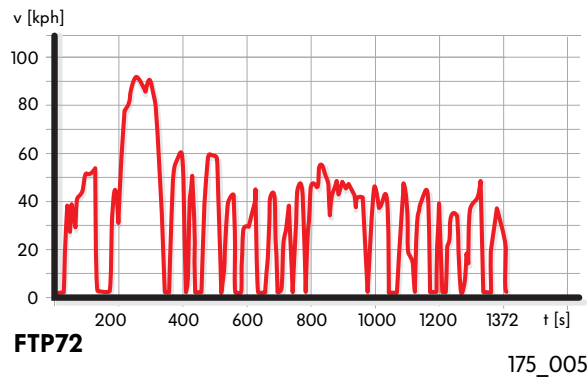

MIL (Malfunction Indicator Light)

U.S. designation for self-diagnosis fault warning lamp K83.

The MIL indicates that the Motronic control unit has detected a fault in components affecting exhaust emissions.

A fault is indicated in the form of a steady or a flashing light after it is detected by the control unit either

- immediately or
- after 2 driving cycles

depending on the nature of the fault and what display conditions apply.

There are also faults which are stored to memory but which do not activate the self-diagnosis fault warning lamp (MIL).

NO_x (nitrogen oxides)

Nitrogen oxide compounds. The NO_x component in motor vehicle exhaust emissions is based on the presence of atmospheric nitrogen during fuel combustion under high pressure and at high temperatures in the engine.

CO (carbon dioxide)

occurs during the combustion of carbon in an oxygen-deficient atmosphere.

HC (hydrocarbons)

Within the context of the exhaust system, the HC component is the concentration of unburnt fuel in the exhaust gas.

Stoichiometric

In vehicle production, a stoichiometric fuel-air mixture is the ideal intake air to fuel mass ratio at which the fuel is burnt completely without producing any incompletely burnt subproducts (e.g. carbon dioxide).

Readiness Code

8-digit binary code which indicates whether all diagnoses affecting exhaust emissions have been conducted by the engine management system.

The Readiness Code is generated when:

- all diagnoses have been conducted without fault and the self-diagnosis fault warning lamp (MIL) is not lit,
- all diagnoses have been conducted, detected faults have been stored to fault memory and indicated by the self-diagnosis fault warning lamp (MIL).

OBD-II

Diagnosis

Stored malfunctions can be exported by means of a Scan Tool connected to the diagnosis interface which can be accessed from the driver's seat.

In the new program version, the diagnosis with VAG 1551 offers the following possibilities:

- Read out/erase fault memory
- Display data relevant to assemblies to support troubleshooting
- Read Readiness Codes
- Execute a short trip (to generate the Readiness Codes)
- Print diagnosis data

Lawmakers have stipulated that diagnosis systems must be designed by auto makers in such a way that OBD data can be interrogated with any OBD reader (Generic Scan Tool).

This Generic Scan Tool mode can be invoked by diagnosis systems

V.A.G 1551 (software version 5.0 or higher),
V.A.G 1552 (software version 2.0 or higher) and
VAS 5051 via address word "33".

However, the units can also provide - via address word "01" - functions which go far beyond this mode and are required for troubleshooting and repair work as well as reading and generating Readiness Codes.

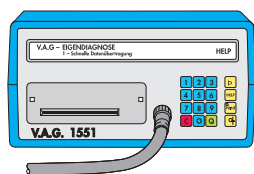

175_006



175_007

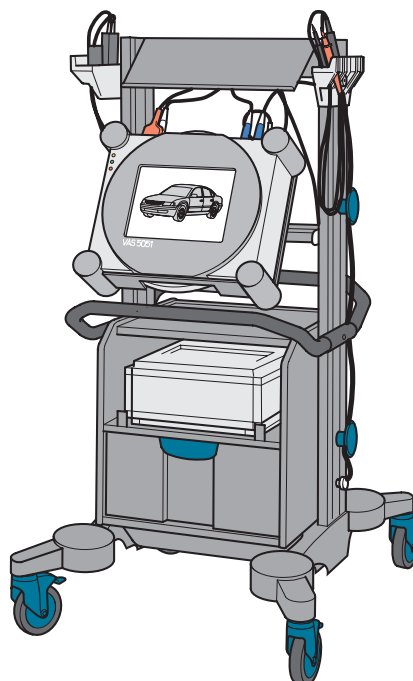

175_010



Overview of OBD-II (Gasoline Engine)

Fault indication

If the system detects a malfunction affecting exhaust emissions, it indicates this fault to the driver by means of a warning lamp which is integrated in the instrument panel at an easily noticed location.

Diagnosis interface

This interface is integrated in the passenger cabin and is within easy access of the driver's seat.



175_008

Self-diagnosis fault warning lamp (MIL) in dash panel insert



175_902

Diagnosis interface

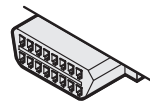

175_912

Self-diagnosis fault warning lamp (MIL) in the New Beetle (U.S.A.)

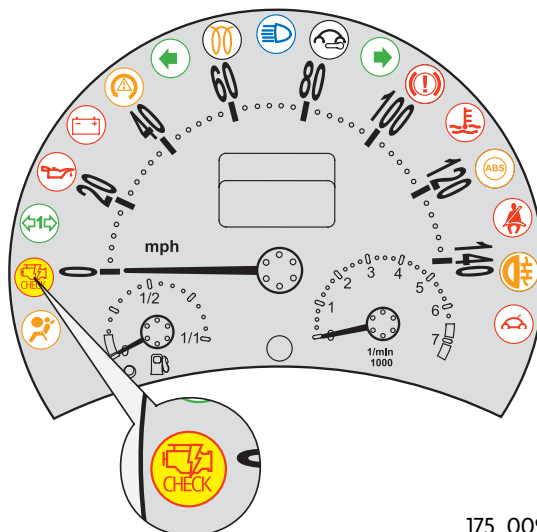

175_009



The driver or mechanic must check that the MIL functions correctly during the starting cycle. The MIL must come on approx. 2 seconds after starting the engine.

Fault indication by self-diagnosis fault warning lamp K83 (MIL)

If misfiring, which can damage the catalytic converter, occurs, the self-diagnosis fault warning lamp (MIL) must indicate this immediately by flashing. The vehicle can then only be operated at a reduced power output.

The self-diagnosis fault warning lamp (MIL) switches to steady light.

If the fault causes a deterioration in emission quality, the self-diagnosis fault warning lamp (MIL) must indicate the fault by a steady light after fulfilling the relevant storage and switch-on conditions (immediately, after 2 driving cycles).

Example: Misfiring

Under all driving conditions the system checks whether:

1. The number of misfires is high enough to damage the catalytic converter,
2. the number of misfires causes the emission values to deteriorate by a factor of 1.5.

If the 1st condition is met, the self-diagnosis fault warning lamp (MIL) must flash once a second.

If the 2nd condition is met, then a fault is stored at the end of the first driving cycle but the self-diagnosis fault warning lamp (MIL) does not come on.

If the fault continues to exist until the end of the second driving cycle, the fault warning lamp must be steady on.

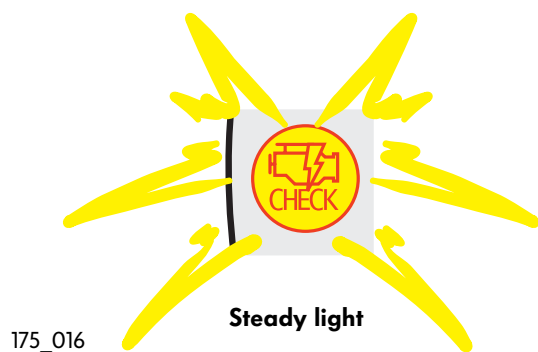
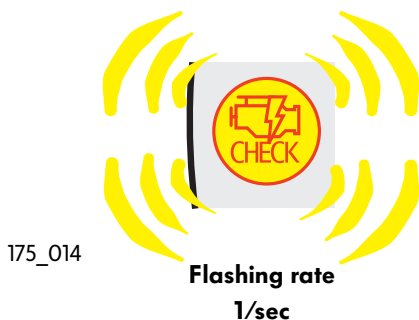

Overview of OBD-II (Gasoline Engine)

On-Board Diagnosis

The diagnosis fault codes are standardized to SAE and must be used in a harmonized fashion by all manufacturers.

The fault code always consists of a five-character alphanumeric value, e.g. P0112.

The first character is a letter. It identifies the system type:

Pxxxx for drive

Bxxxx for body

Cxxxx for suspension and

Uxxxx for future systems

Only P-codes are required for OBD II.

The second character identifies the standard code.

P0xxx Freely selectable fault codes defined in accordance with SAE which can be used by the diagnosis system and contain specified fault texts (from model year 2000: P0xxx and P2xxx).

P1xxx Additional freely selectable fault codes affecting exhaust emissions which are offered by the manufacturer and contain no specified fault texts but must be registered with lawmakers (from model year 2000: P1xxx and P3xxx)

The third character indicates the module in which the fault occurs:

Px1xx Fuel and air metering

Px2xx Fuel and air metering

Px3xx Ignition system

Px4xx Additional emission control

Px5xx Cruise and idle speed control

Px6xx Computer and output signals

Px7xx Transmission

The fourth and fifth characters contain the component/system IDs.

When carrying out a diagnosis, you can initiate different diagnosis functions by entering different address words.

The Scan Tool Mode is started by entering the key "33".

It includes all functions stipulated for a generic Scan Tool by lawmakers within the framework of the OBD. In this context, individual physical data (e.g. Lambda probe data) can be exported.

Workshops with universal diagnosis units such as the VAG 1551/1552 can optimize troubleshooting by accessing all key engine data by entering the key "01". In the Bosch Motronic, the Readiness Code can also be generated by taking the vehicle out on a short trip.



If no faults are stored in the fault memory, do not erase the fault memory unnecessarily, otherwise this will reset the Readiness Code.

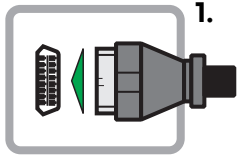

1. Connect diagnosis system to diagnosis interface. Switch on unit.

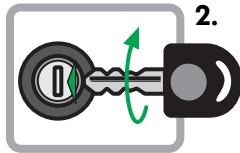

2. Ignition "On".

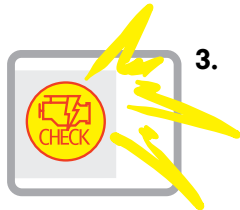

3. Self-diagnosis fault warning lamp (MIL) indicates faults.

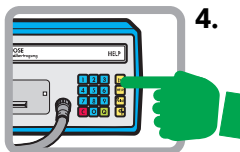

4. Entry "1" for rapid data transfer.

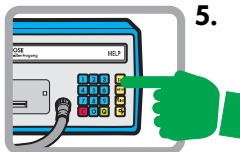

5. Entry "01". Address word for engine electronics.

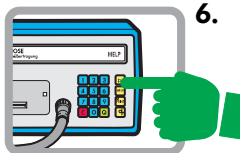

6. Entry "Q". Acknowledge entry.

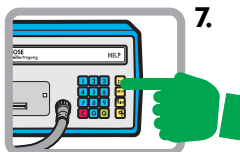

7. Entry "Print". Switches printing mechanism on.

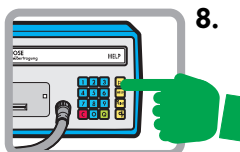

8. Entry "02" for Interrogate Fault Memory

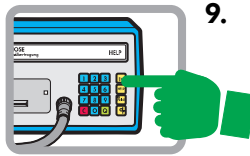

9. Entry "Q". Acknowledge entry.

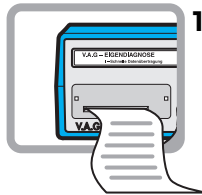

10. The fault messages stored in the fault memory are printed in alphanumeric text.

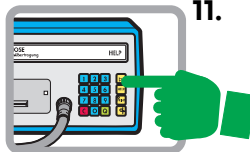

11. Entry "06" for End of Output.

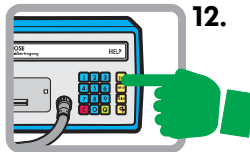

12. Entry "Q". Acknowledge entry.

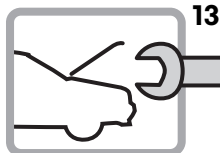

13. Remedy fault.

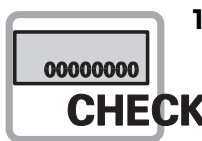

14. After fault correction, erase fault memory and generate Readiness Code by short trip. (Motronic M5.9.2).

175_903-
175_910



Overview of OBD-II (Gasoline Engine)

The display on the diagnosis system in OBD II Scan Tool Mode

This display appears after you enter "1" (for rapid data transfer) followed by "33" (for activate Scan Tool function).



OBD II Scan Tool							
Select Mode	1..	2..	3..	4..	5..	6..	7.. 8..

For example, the following display appears after you select Mode 1.

This display contains various display fields which display the diagnosis data.

From here, you can select the various PIDs (e.g. PID 5 = engine temperature, PID 16 = air mass flow rate).

Mode display

7 modes are selectable (41 - 47)
e.g. 41
= Diagnosis data transmitted

Parameter identification
PID1
= Fault code
POxxx/Plxxx

Name of module
Module 10
= Motronic control unit
Module 1a
= Transmission control unit

Mode 41	PID1	Module 10	
00000000	00000111	01101101	00000000

Display field 1
Number of stored faults;
self-diagnosis fault warning lamp (MIL)
On/Off

Display field 2
ongoing diagnosis (e.g. misfiring recognition)

Display field 3
Displays whether components are supported by the diagnosis.

Display field 4
Indicates whether the Readiness Code was set.



The readiness display "00000000" only indicates that all individual diagnosis affecting exhaust emissions were conducted in accordance with regulations. A "0" is set to denote a completed individual diagnosis even if a fault was detected and stored.

Here is an example

The Motronic control unit was disconnected from the battery and the self-diagnosis fault warning lamp (MIL) is not on.



Mode 47	PID2	Module 10	
1000010	0000111	01101101	01101101

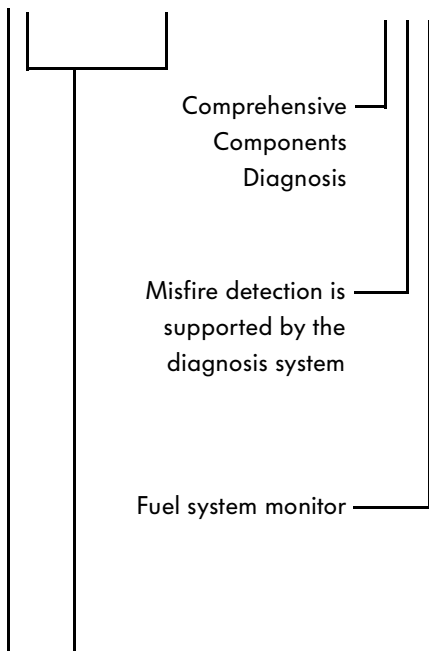

The number of faults is indicated by a 7-digit binary code.
 e.g.: 0000010
 denotes: 2 fault detected.

If the 8th digit is a "1", it denotes:
 Self-diagnosis fault warning lamp (MIL) switched on.

For the purpose of our example, this means:

As the self-diagnosis fault warning lamp (MIL) does not come on but was switched on by the system, a fault must have occurred here.

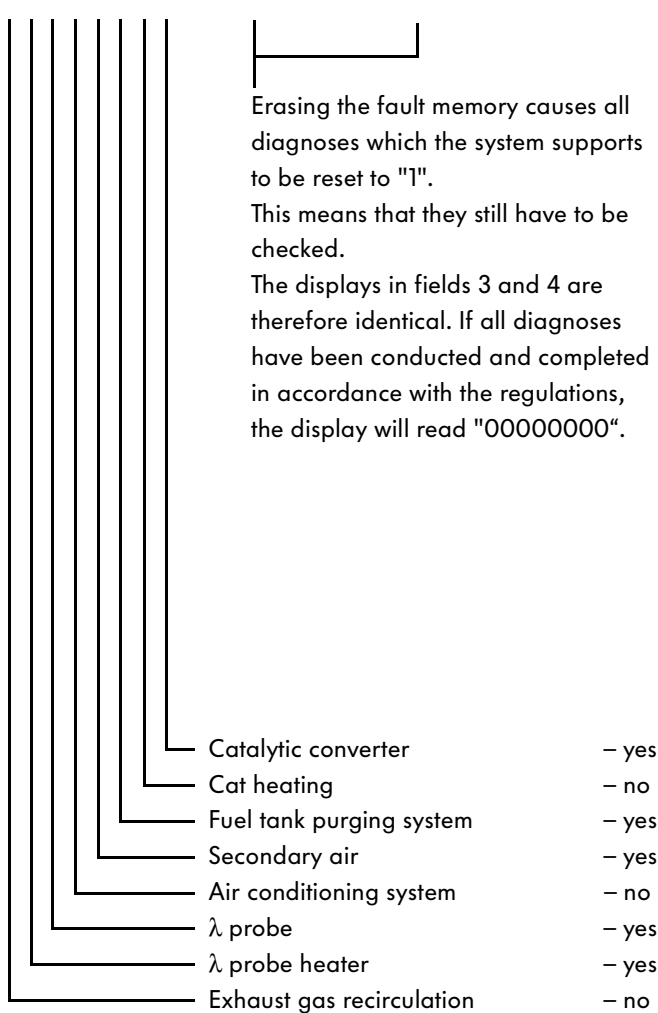

Erasing the fault memory causes all diagnoses which the system supports to be reset to "1".
 This means that they still have to be checked.
 The displays in fields 3 and 4 are therefore identical. If all diagnoses have been conducted and completed in accordance with the regulations, the display will read "00000000".

- Catalytic converter – yes
- Cat heating – no
- Fuel tank purging system – yes
- Secondary air – yes
- Air conditioning system – no
- λ probe – yes
- λ probe heater – yes
- Exhaust gas recirculation – no

Overview of OBD-II (Gasoline Engine)

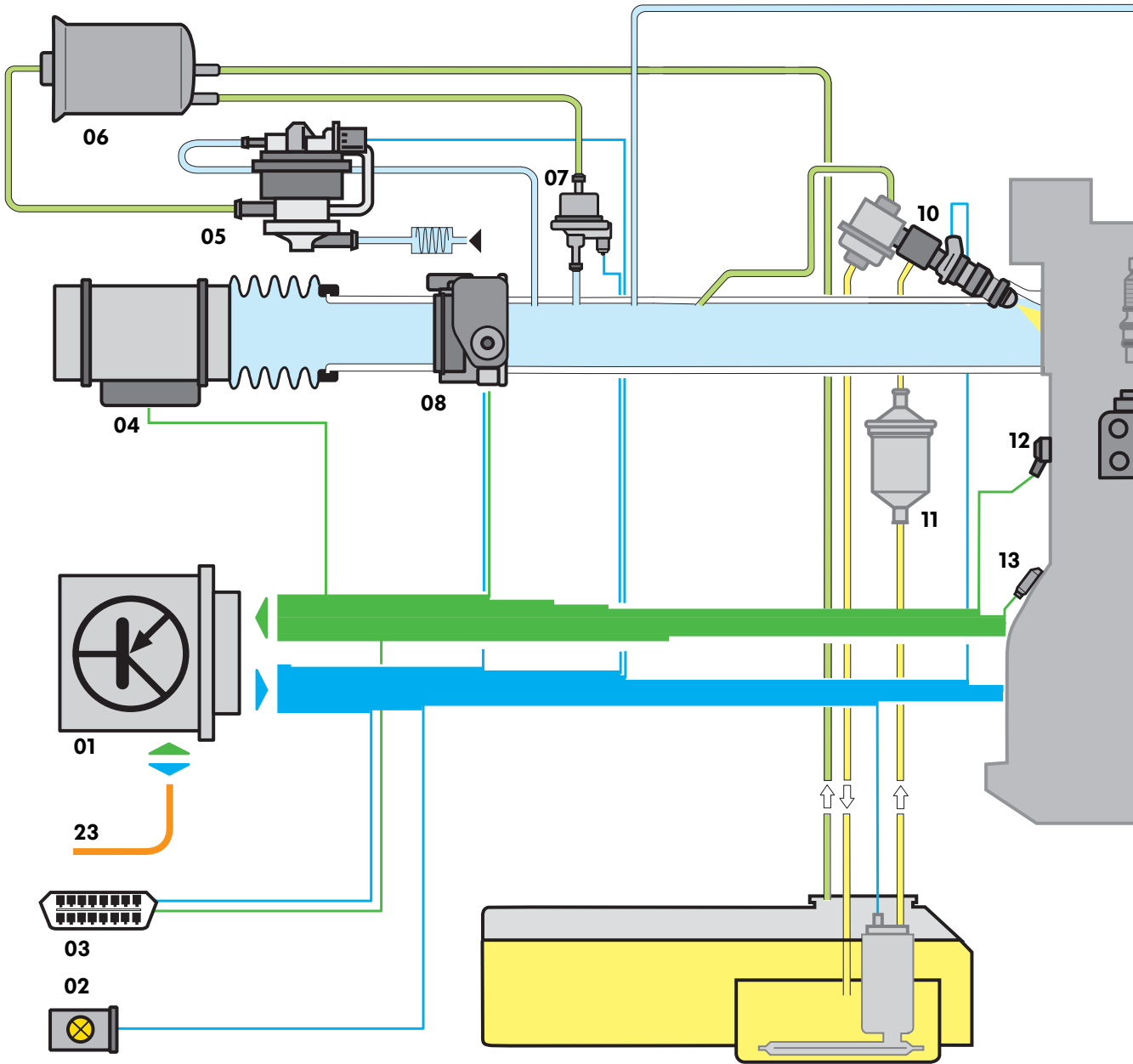

System components 2.0-liter gasoline engine

Legend

- 01 Motronic control unit J220
- 02 Self-diagnosis fault warning lamp K83 (MIL)
- 03 Diagnosis interface
- 04 Air-mass flow meter G70
- 05 Fuel system diagnosis pump V144
- 06 Activated charcoal canister
- 07 Activated charcoal filter system N80 solenoid valve 1
- 08 Throttle valve control unit J338
- 09 Speedometer sender G22
- 10 Injector, cylinders 1-4 N30-33
- 11 Fuel filter
- 12 Knock sensors I+II G61, G66
- 13 Engine speed sender G28
- 14 Hall sender G40
- 15 Static high-voltage distributor
- 16 Coolant temperature sender G62
- 17 Secondary air inlet valve N112
- 18 Secondary air pump motor V101
- 19 Secondary air pump relay J299
- 20 Combination secondary air valve
- 21 Lambda probe I G39 (primary catalytic converter probe)
- 22 Lambda probe II G108 (secondary catalytic converter probe)
- 23 CAN bus

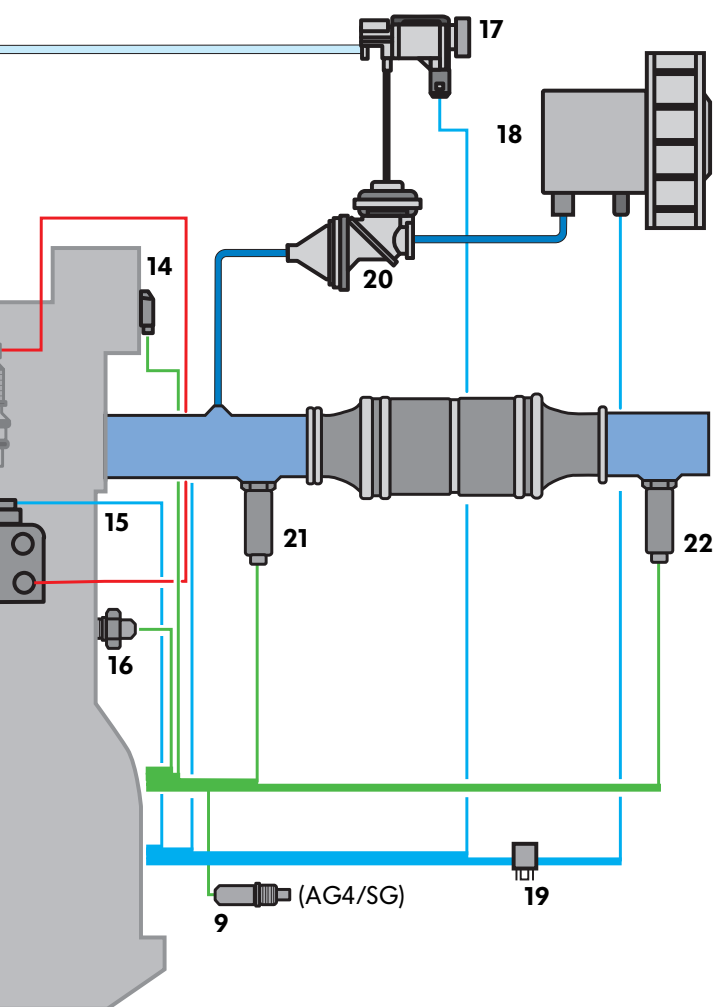

175_914



System Overview (Gasoline Engine)

Sensors

Lambda probe I **G39**
(primary catalytic converter probe)

Lambda probe II **G108**
(secondary catalytic converter probe)

Air-mass flow meter **G70**

Knock sensors I+II **G61, G66**

Engine speed sender **G28**

Hall sender **G40**
(camshaft position sensor)

Speedometer sender **G22**

Coolant temperature sender **G62**

Throttle valve control unit **J338**
integr.:
Throttle valve potentiometer **G69**
Throttle valve positioner potentiometer **G88**
Idling speed switch **F60**

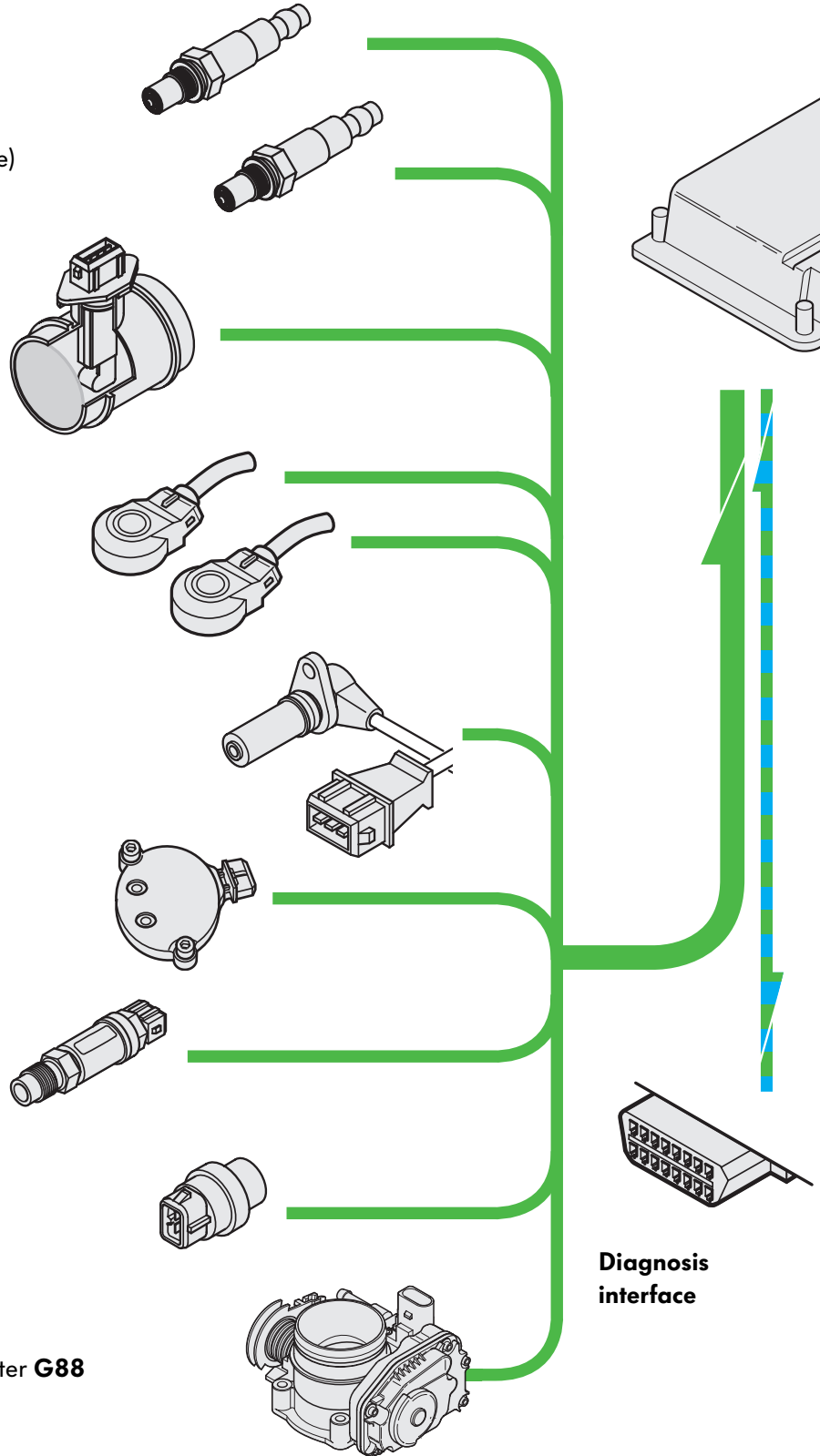

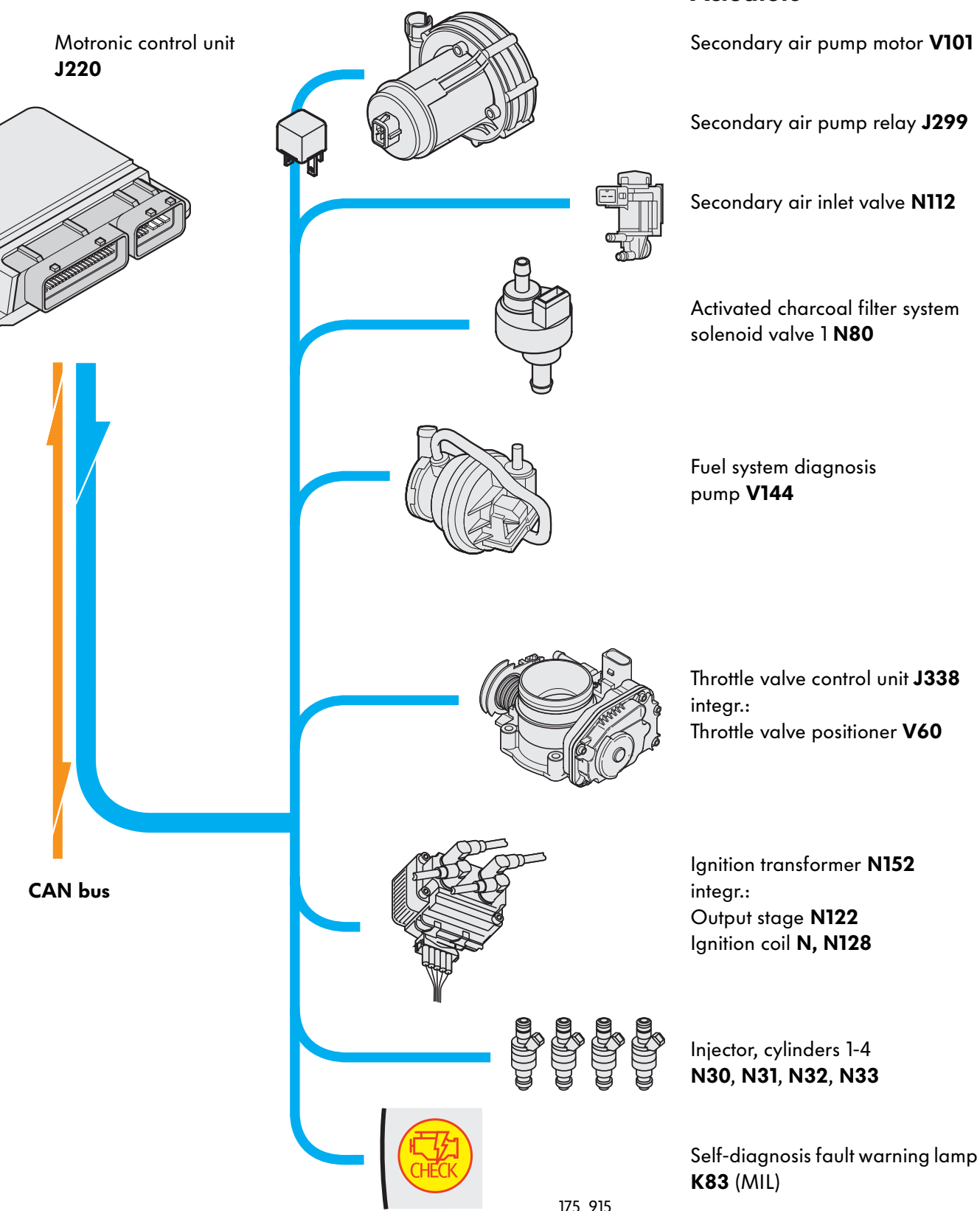

Motronic control unit
J220

Actuators

Secondary air pump motor **V101**

Secondary air pump relay **J299**

Secondary air inlet valve **N112**

Activated charcoal filter system
solenoid valve 1 **N80**

Fuel system diagnosis
pump **V144**

Throttle valve control unit **J338**
integr.:
Throttle valve positioner **V60**

Ignition transformer **N152**
integr.:
Output stage **N122**
Ignition coil **N, N128**

Injector, cylinders 1-4
N30, N31, N32, N33

Self-diagnosis fault warning lamp
K83 (MIL)



System Components (Gasoline Engine)

The catalytic converter

The catalytic converter is the key component for emission control. Whereas development began with the open-loop system, today a closed-loop system regulated exclusively by lambda probes is used in the motor vehicle industry.

A catalytic converter in the chemical sense is a substance which promotes, accelerates or makes possible a chemical reaction.

The substance itself - in this case, precious metals such as platinum, rhodium and/or palladium are used - does not take part in the reaction and is not used up.

For reasons of effectiveness, it is important for the surface of catalytic converter to be as large as possible. Therefore, the precious metal is applied to a ceramic or metallic substrate bearing numerous longitudinal channels. The surface area was again enlarged by means of a so-called wash coat. This is what makes highly efficient exhaust gas treatment possible.

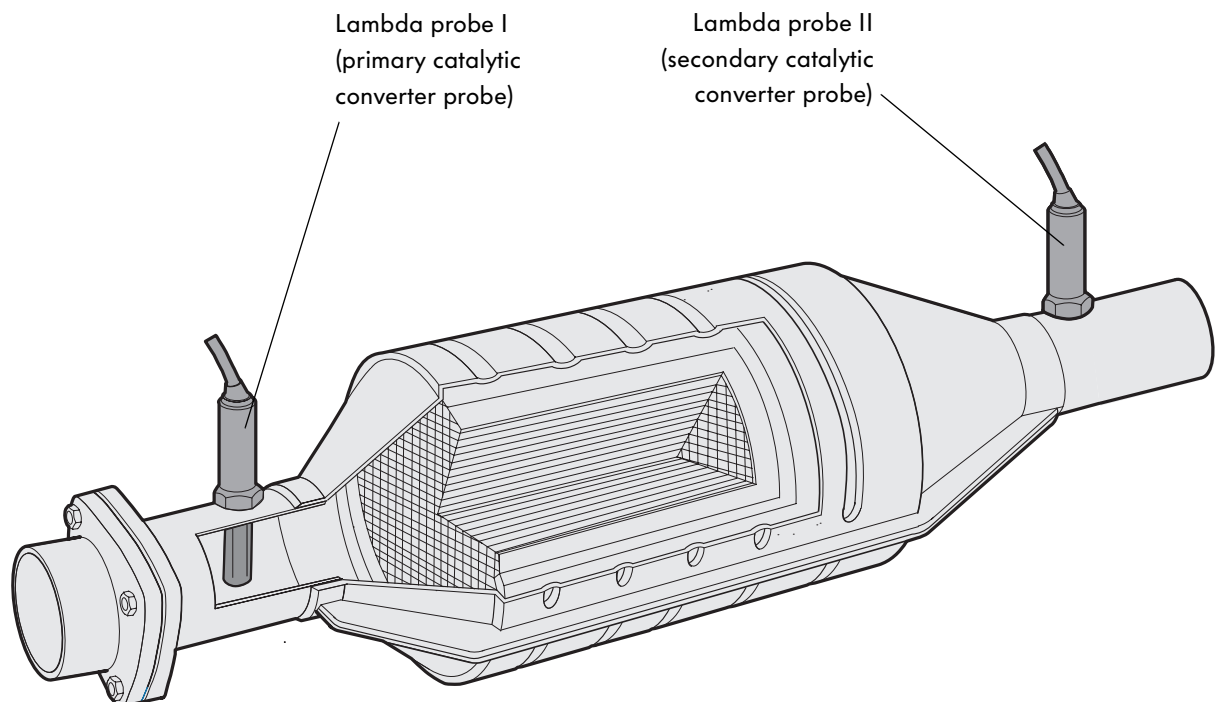

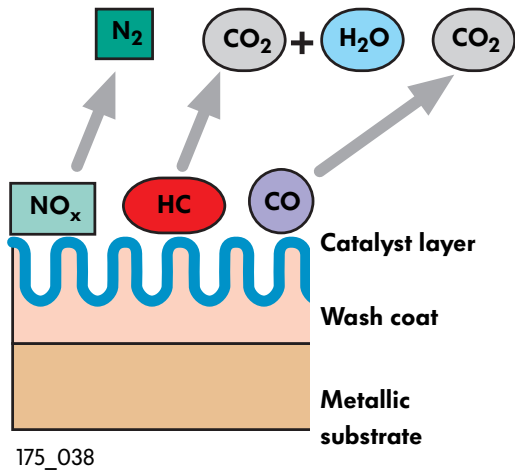

Catalytic exhaust gas treatment

Two opposite chemical reactions take place inside the catalytic converter: Carbon dioxide and hydrocarbons are oxidized to carbon dioxide and water, and nitrogen oxides are reduced to nitrogen and oxygen. The reduction and oxidation processes are promoted by low and high oxygen levels, respectively.

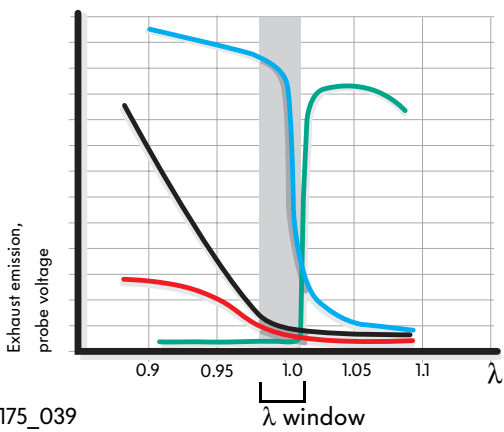

- HC
- CO
- NO_x
- Lambda probe voltage

By altering the oxygen to exhaust gas mixture ratio the system can be regulated so that both reactions take place within an optimal range ($\lambda=0.99$ to 1). This range is known as the lambda window. The control values are transmitted by lambda probes. (λ =lambda)

System Components (Gasoline Engine)

Was does OBD II test?

An aged or faulty catalytic converter has less oxygen absorption capacity. Therefore its conversion capability is impaired. If the valid limit values for the concentration of hydrocarbons in the exhaust gas during of a mandatory emissions test are exceeded by a factor of 1.5, this must be detected on-line.

Catalytic conversion diagnosis

During the diagnosis, the Motronic control unit compares the voltages of the primary and secondary catalytic converter probes. It determines what is known as the primary to secondary catalytic converter ratio (lambda probes I+II).

The engine management system interprets any deviation from the nominal range as a malfunctioning of the catalytic converter. After meeting the fault conditions, the fault code is saved to fault memory. The fault is indicated by the self-diagnosis fault warning lamp (MIL).

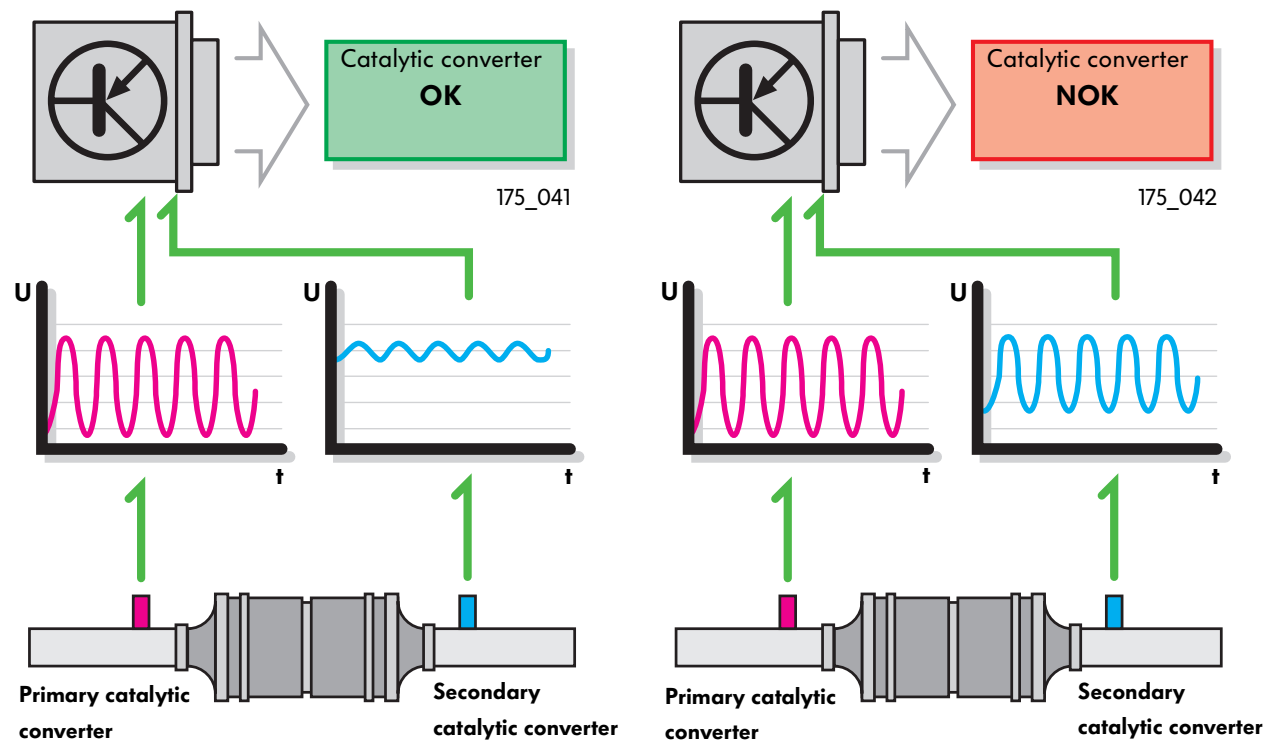

V = voltage, t = time

Hazards to the catalytic converter

As a result of the prevailing temperature conditions, catalytic converters are subjected to an aging process that affects their conversion characteristics.

In addition to this thermal aging process, the conversion characteristics of the catalytic converter may also be impaired by poisoning (chemical aging).

For example, if misfiring occurs in the catalytic converter during operation as a result of high temperatures, the active catalyst surface may become damaged.

Mechanical damage to the catalytic converter is also possible.

Emission limits for gasoline vehicles

Two examples of the currently valid limit values are shown here. However, these values cannot be compared with one another because different test methods are used.

- The limit values for passenger cars which are approved for max. 12 persons applicable in the U.S. Federal State of California with effect from model year 1999.

The limit values conform to the LEV approval level.

Pollutant	Durability [mi]	Limit value MY '99 [g/mi]
NMOG	50,000	0.075
	100,000	0.09
CO	50,000	3.4
	100,000	4.2
NO _x	50,000	0.2
	100,000	0.3

175_043

NMOG (Non-Methane Organic Gases) is the sum of all oxygen-containing and oxygen-free hydrocarbons in the exhaust gas.

- The limit values currently in force in the Federal Republic of Germany comply with the D3 standard.

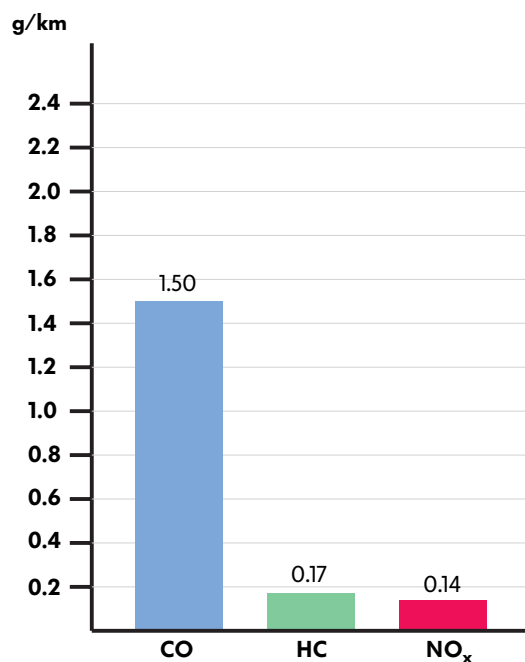

175_155



System Components (Gasoline Engine)

The lambda probe

The lambda probe measures the oxygen component in the exhaust gas mixture. It is an integral part of a closed control loop which maintains the correct composition of the air-fuel mixture.

The air-oxygen-to-fuel mixing ratio at which maximum conversion of the pollutants takes place in the catalytic converter is $\lambda=1$ (stoichiometric mixing ratio).

Changes in exhaust gas composition are compensated for by the engine management system when it controls a number of functions and often serve as an early indication of a possible fault.

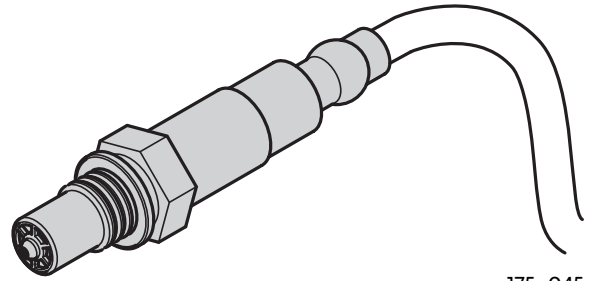

175_045

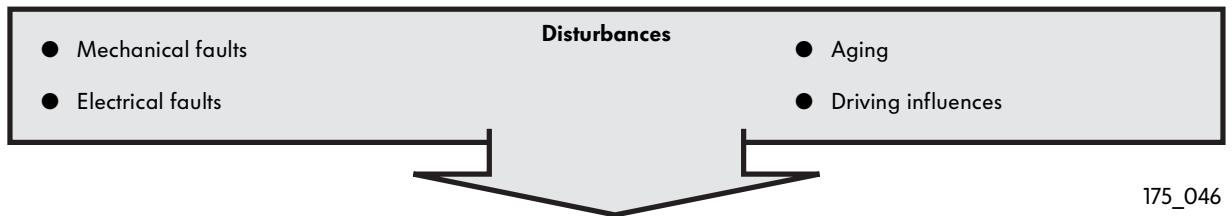

175_046

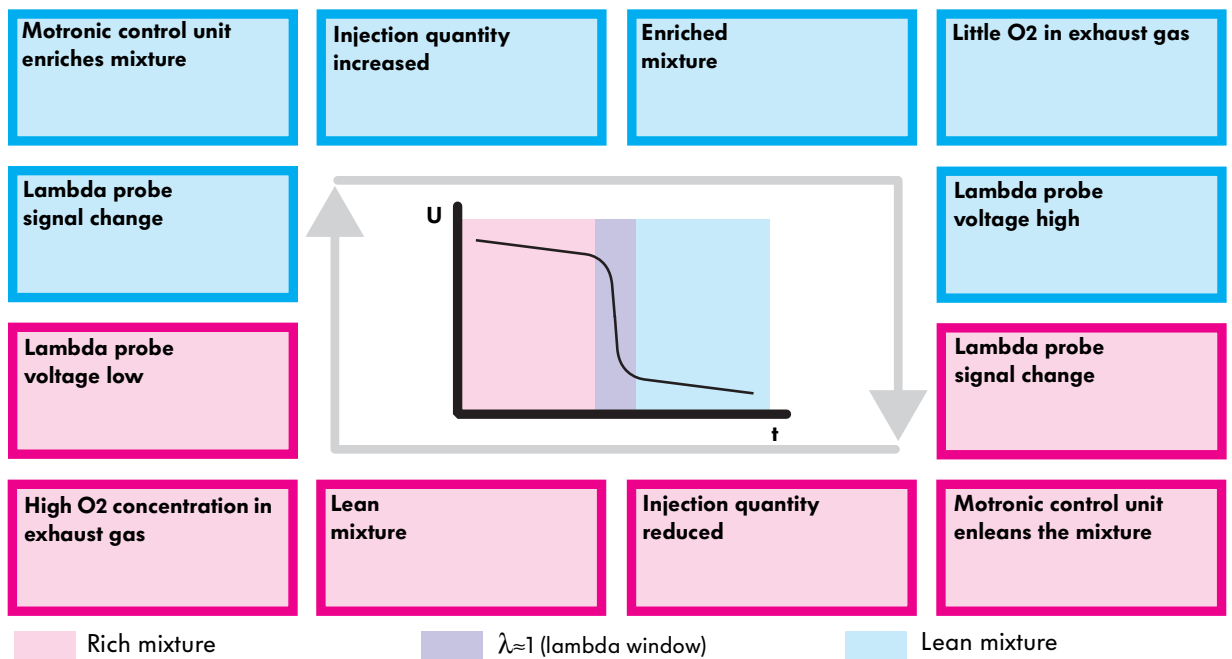

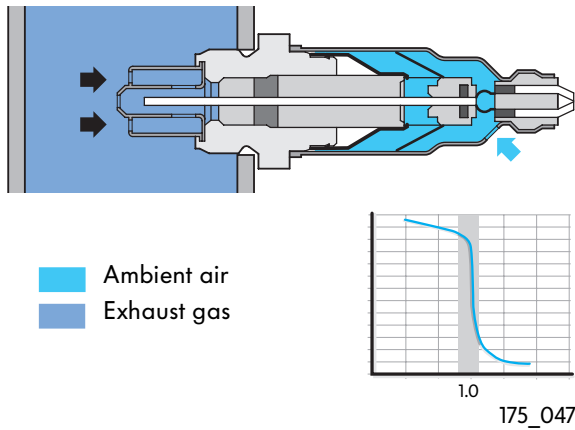

Functional description

The difference in oxygen content between the exhaust gas and ambient air causes a change in the electrical voltage within the probe.

A change in the composition of the fuel-air mixture produces a sudden voltage change by which $\lambda=1$ can be identified.

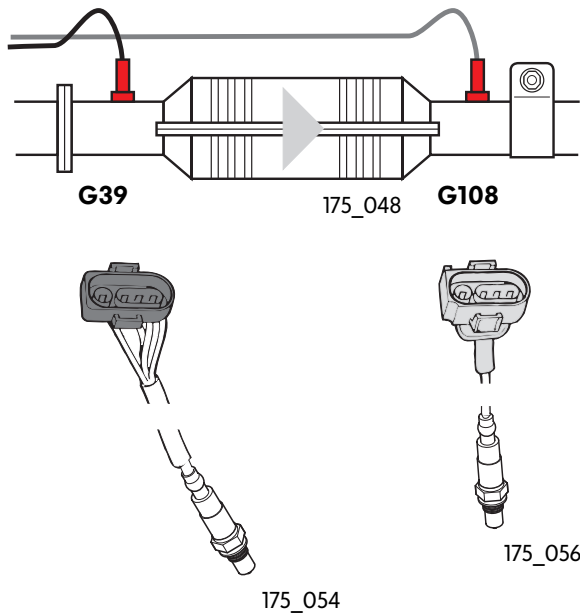
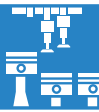

Lambda control in OBD II

In connection with OBD II, an additional lambda probe G108, located behind the catalytic converter is integrated in the system (secondary catalytic converter probe). It tests correct functioning of the catalytic converter. In the Motronic M5.9.2, the lambda probe G39 (primary catalytic converter probe) is also adapted.

Different connector types and connector colors avoid any confusion in connector location.

Requirement

An aged or defective primary catalytic converter probe prevents optimum adjustment of the air-fuel mixture and leads to a deterioration in the vehicle's emission and performance data.

This must therefore be detected by the engine management system after fulfilling the fault conditions, stored as a fault and indicated.

System Components (Gasoline Engine)

Lambda control

OBD II checks with regard to lambda control:

- response/aging characteristics
- voltage applied to lambda probes
- probe heater

Lambda probe aging diagnosis

Aging or poisoning can adversely affect the response of a lambda probe. A deterioration can become noticeable by an increase in probe reaction time (period duration) or a shift in the probe voltage curve (probe shift). Both situations lead to a reduction in the λ window and to poorer exhaust gas conversion in the catalytic converter.

A change in reaction time can be acquired, stored and displayed but cannot be compensated for.

In the Motronic M5.9.2, the shift in the voltage curve is corrected within a defined framework by means of a second closed control loop (adaption).

Testing the reaction time of the primary catalytic converter probe

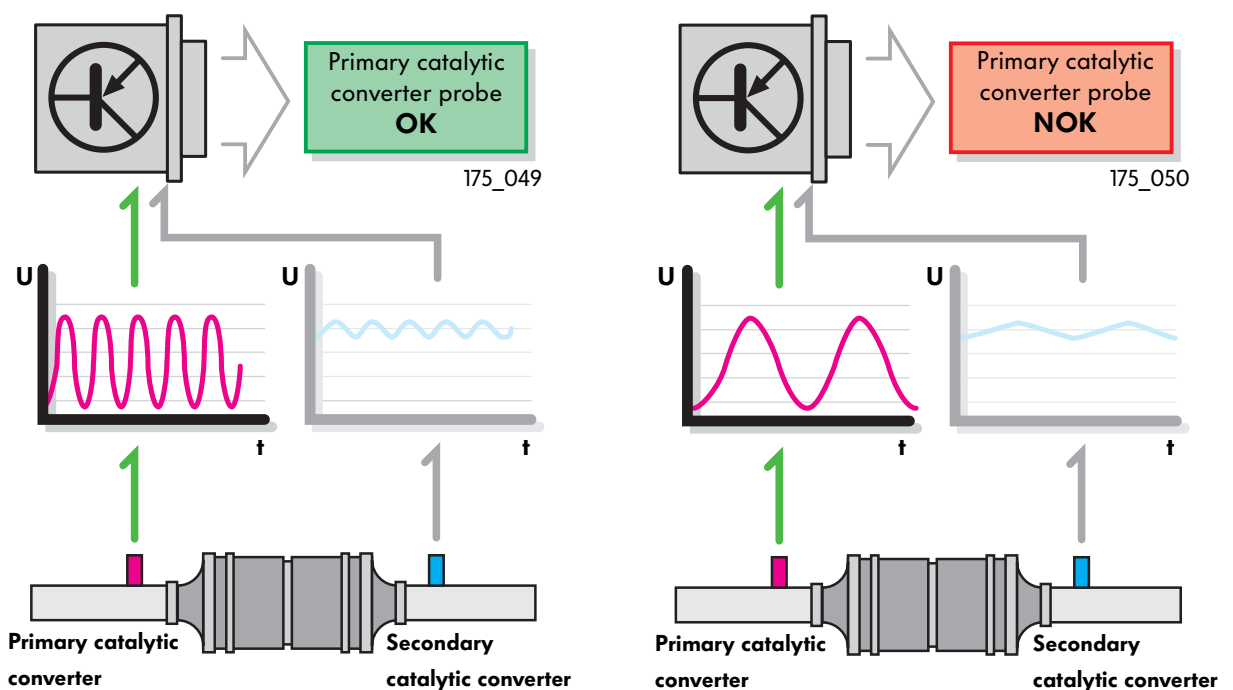

Testing and adaption of the voltage curve shift of the primary catalytic converter probe

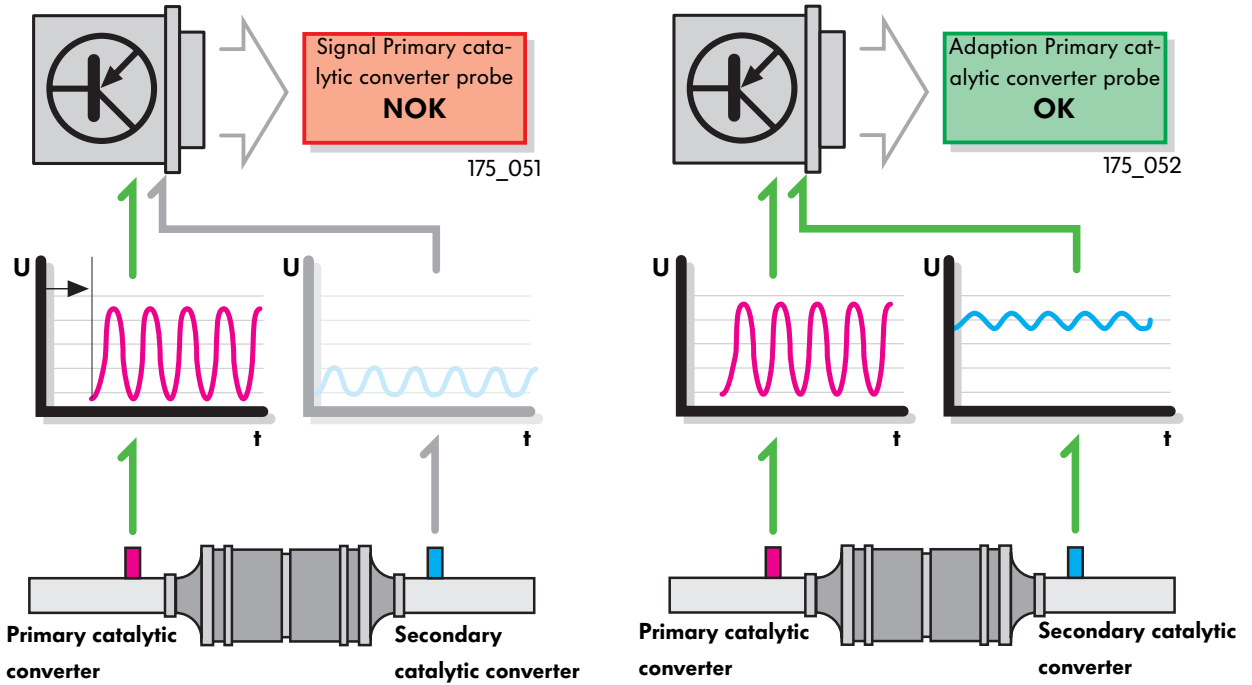

Closed control loop, lambda probe adaption

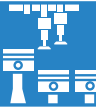
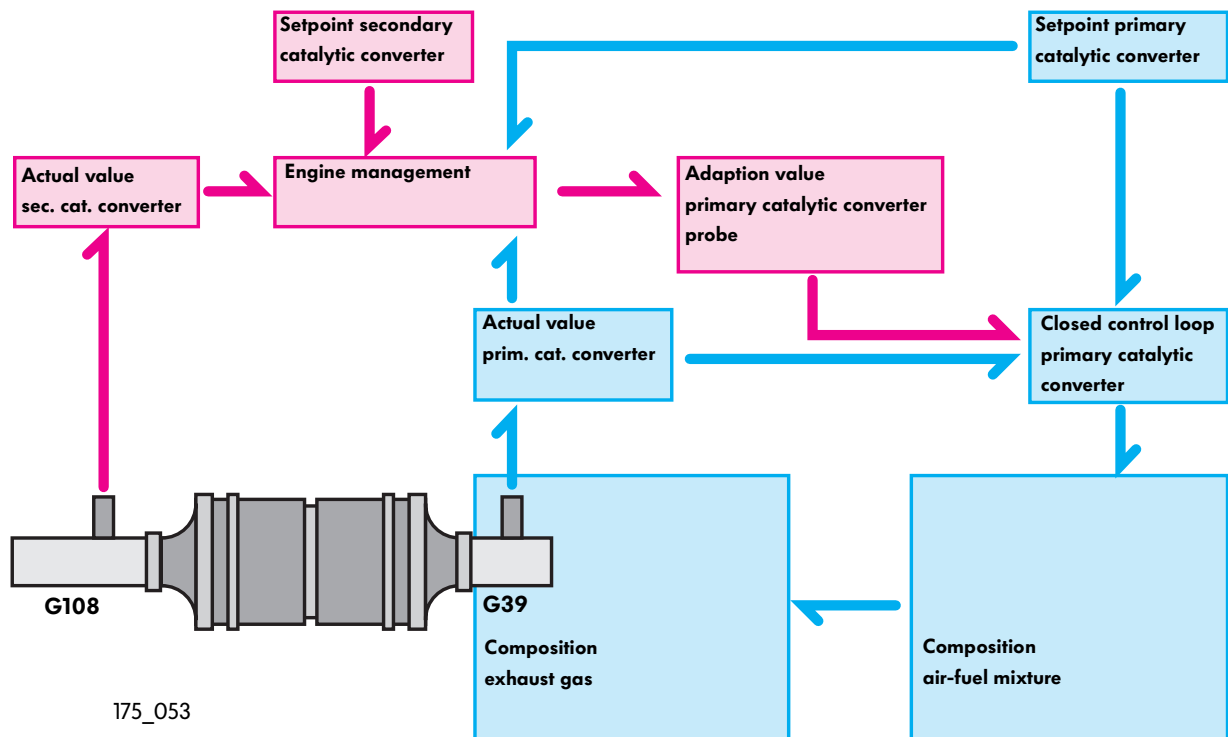

System Components (Gasoline Engine)

Lambda probe voltage tester

The lambda probe voltage tester tests the electrical function of the probe. The system detects and differentiates between short-circuits to positive and ground, as well as open circuits (e.g. cable breakage). Fault detection is dependent on whether the signal is too high or too low.

Lambda probe G39

is the primary catalytic converter probe.

Effects of signal failure

If the lambda probe signal fails, lambda control does not take place and the lambda adaption function is disabled. The tank ventilation system goes to emergency mode. The Motronic control unit uses a map-based open control loop as an emergency function.

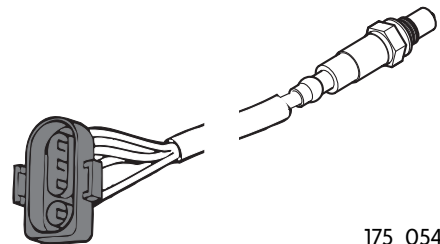

175_054

Electrical circuit

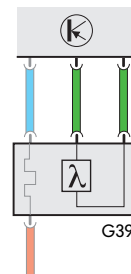

175_055

Lambda probe G108

is the secondary catalytic converter probe.

Effects of signal failure

The engine lambda control remains operational even if the secondary catalytic converter probe fails. Only the function of the catalytic converter can no longer be checked if the probe fails. In the Motronic M5.9.2, the function test on the primary catalytic converter probe no longer takes place.

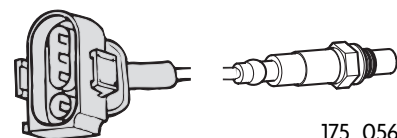

175_056

Electrical circuit

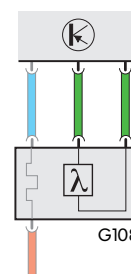

175_055

Heated lambda probe

Advantages:

Since the behavior of the lambda probe is temperature-dependent, the heating allows exhaust gas treatment even at low engine and exhaust-gas temperatures.

Electrical circuits

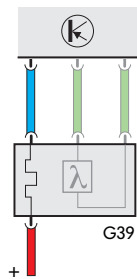

175_058

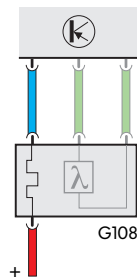

175_058

Lambda probe heater diagnosis

The system recognizes the correct heat output from the measurement for probe heating resistance.

The heated probe may, in unfavourable circumstances, be damaged by the occurrence of condensate, particularly in the cold starting phase. Therefore, the primary catalytic converter probe is heated directly after starting the engine. The secondary catalytic converter probe is not heated until a theoretical temperature of approx. 308°C is exceeded in the catalytic converter.

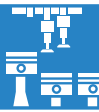

System Components (Gasoline Engine)

The secondary air system

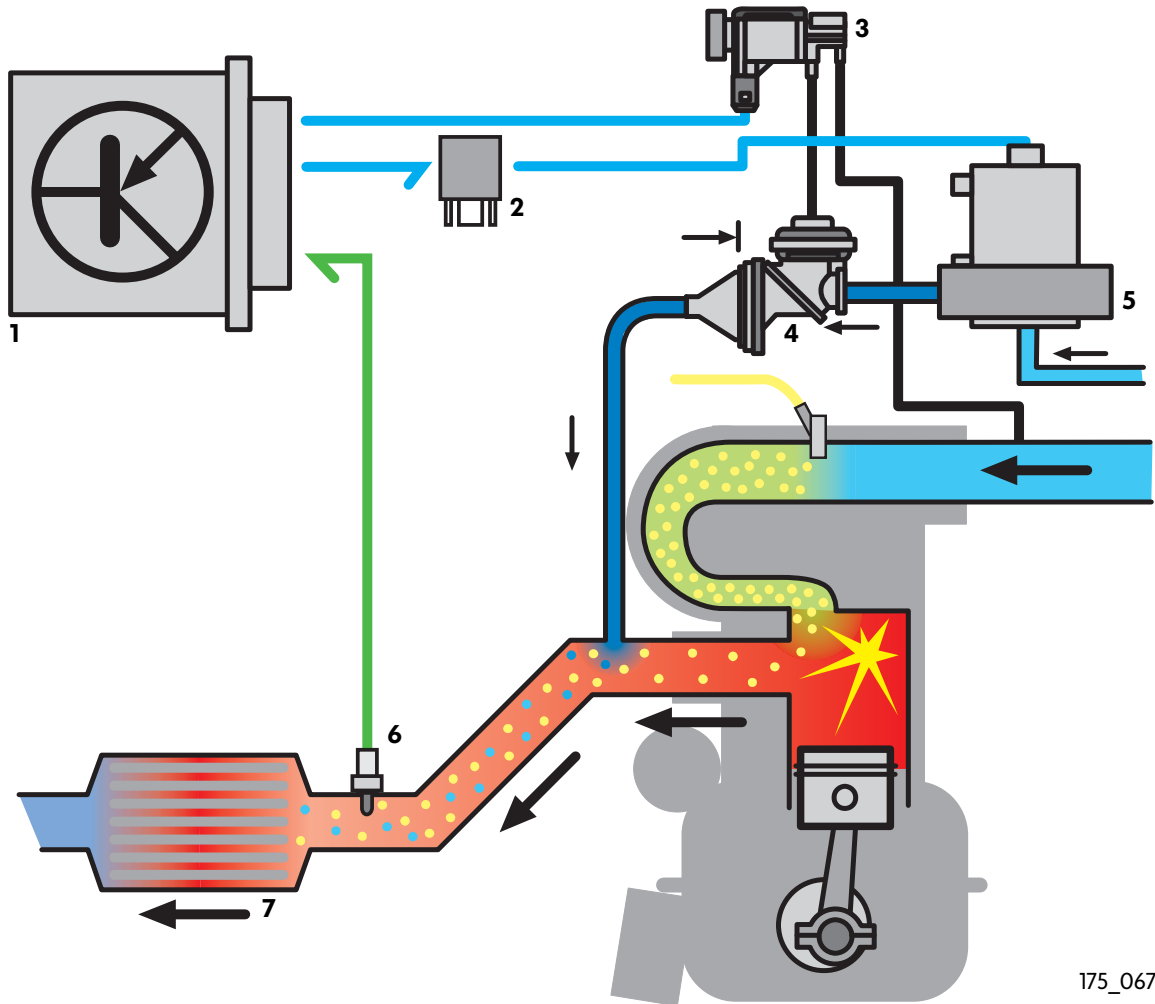

Legend:

- 1 Motronic control unit
- 2 Secondary air pump relay
- 3 Secondary air inlet valve
- 4 Combination valve
- 5 Secondary air pump motor
- 6 Primary catalytic converter probe
- 7 Catalytic converter

Due to over-enrichment of the mixture in the cold starting phase, an increased level of unburned hydrocarbons occurs in the exhaust gas. Secondary air injection improves postoxidation in the catalytic converter and reduces pollutant emission.

The heat released as a result of postoxidation shortens the response time of the catalytic converter considerably, with the result that emission quality improves greatly.

The OBD II checks:

- Flow rate at combination valve
- Flow rate at secondary air pump motor
- electr. function of change-over valve by means of Comprehensive Components Diagnosis
- Electrical function of secondary air pump relay

Procedure:

An activated secondary air system leads to a rise in the oxygen concentration at the lambda probes as a result of the air conveyed by the secondary air pump; the lambda probes detect this (reduced lambda probe voltage) and send a corresponding signal to the Motronic control unit.

If the engine management system sends the 'open' signal to the secondary air inlet valve and switches the pump on, an extremely lean mixture must exist at the lambda probe if the secondary air system is OK. The lambda control then indicates a clear deviation.

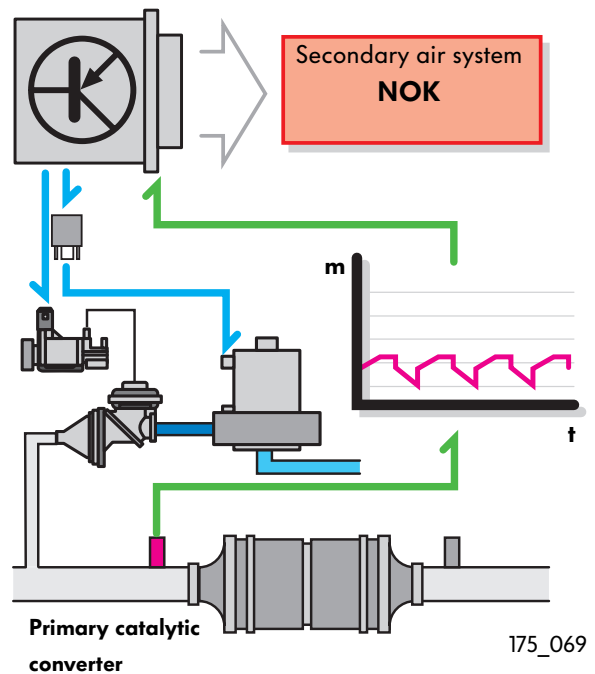
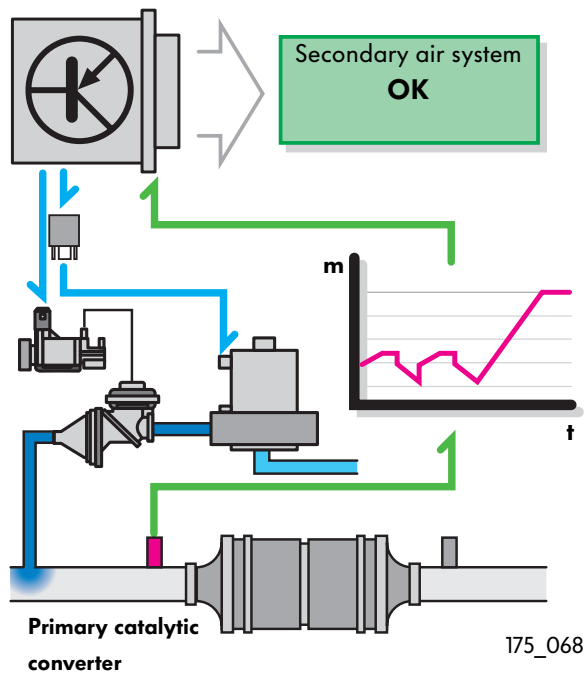
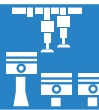

m = control value of lambda controller, t = time

System Components (Gasoline Engine)

Secondary air inlet valve N112

This electrical change-over valve is attached to the engine bulkhead. It controls the combination valve via a vacuum line and is activated directly by the Motronic control unit.

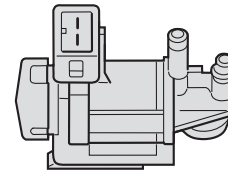

175_071

Effects of signal failure

If the control unit pulse signal fails, the combination valve can no longer open. The secondary air pump cannot inject any air.

Electrical circuit

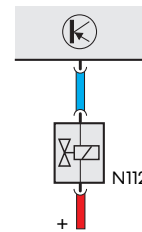

175_072

Secondary air pump relay J299

is activated by the Motronic control unit to switch the secondary air pump motor.

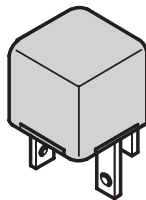

175_073

Electrical circuit

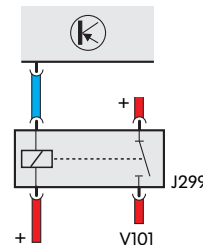

175_074

Secondary air pump motor V101

is activated via a relay. The secondary air pump motor delivers the air mass flow for the secondary air system.

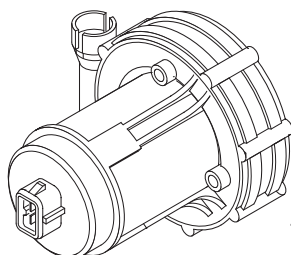

175_075

Electrical circuit

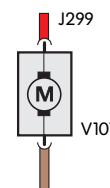

175_076

The tank ventilation system

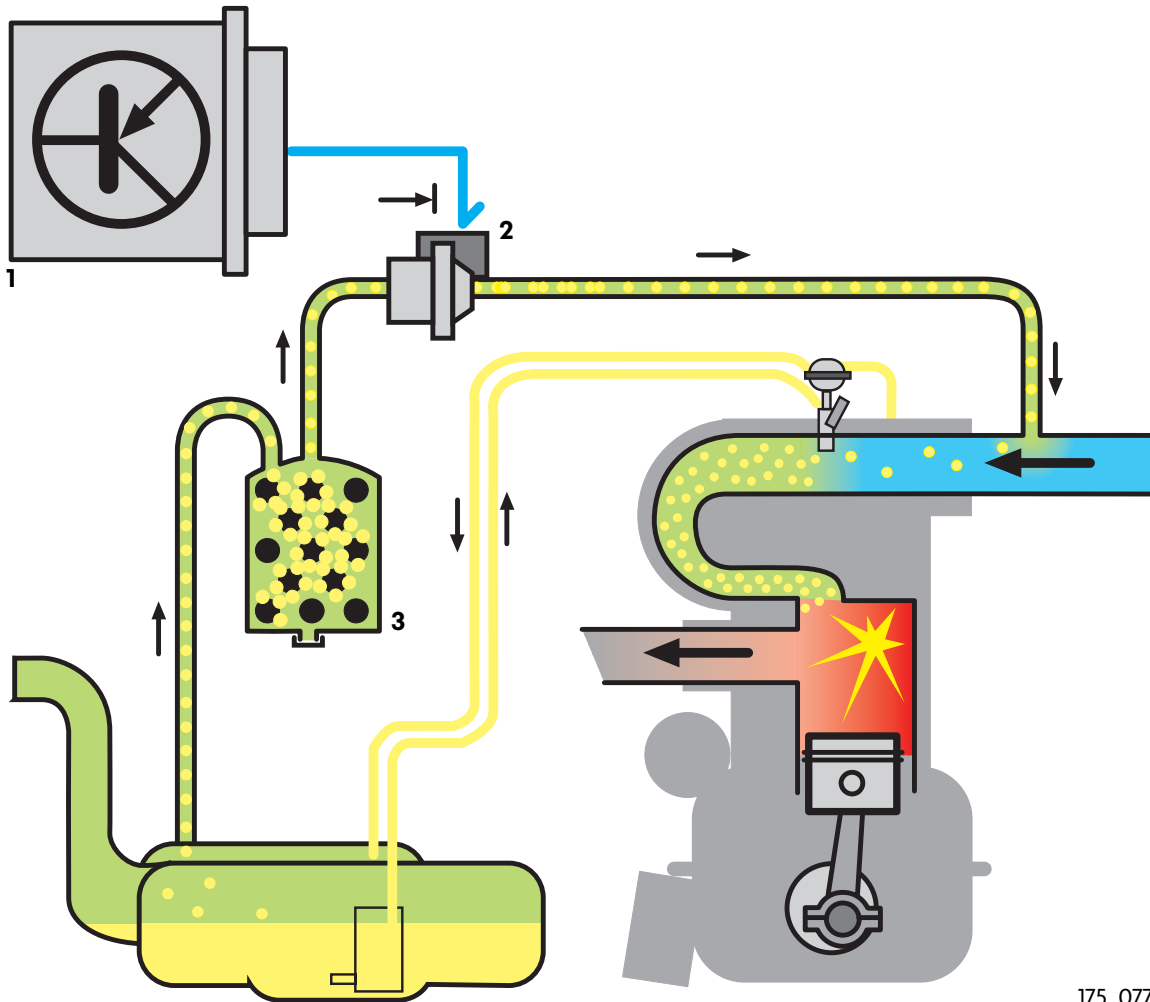

175_077

Legend:

- 1 Motronic control unit
- 2 Activated charcoal filter system solenoid valve 1
- 3 Activated charcoal canister

The tank ventilation system should prevent hydrocarbons escaping into the atmosphere. Therefore, the gasoline vapors which form on the surface of the fuel inside the tank are accumulated in an activated charcoal canister and fed into the intake manifold via a solenoid valve while the engine is running.

The leak testing function can be added to the fuel tank purging system.

System Components (Gasoline Engine)

The tank ventilation system can assume three different states:

1. The activated charcoal canister is empty. The fuel-air mixture is leaned down by activating the fuel tank purging system.
2. The activated charcoal canister is full. The fuel-air mixture is enriched by activating the fuel tank purging system.
3. The activated charcoal canister filling is equivalent to a stoichiometric mixing ratio. The fuel-air-mixture is neither enriched nor leaned down. This state is detected by the idle speed control; states 1+2 are detected by the lambda control.



Fitting location

The activated charcoal canister of the tank ventilation system is not installed in the wheel housing at the front right as in other VW models. Instead, it is located behind the wheel housing liner below the rear right wing.

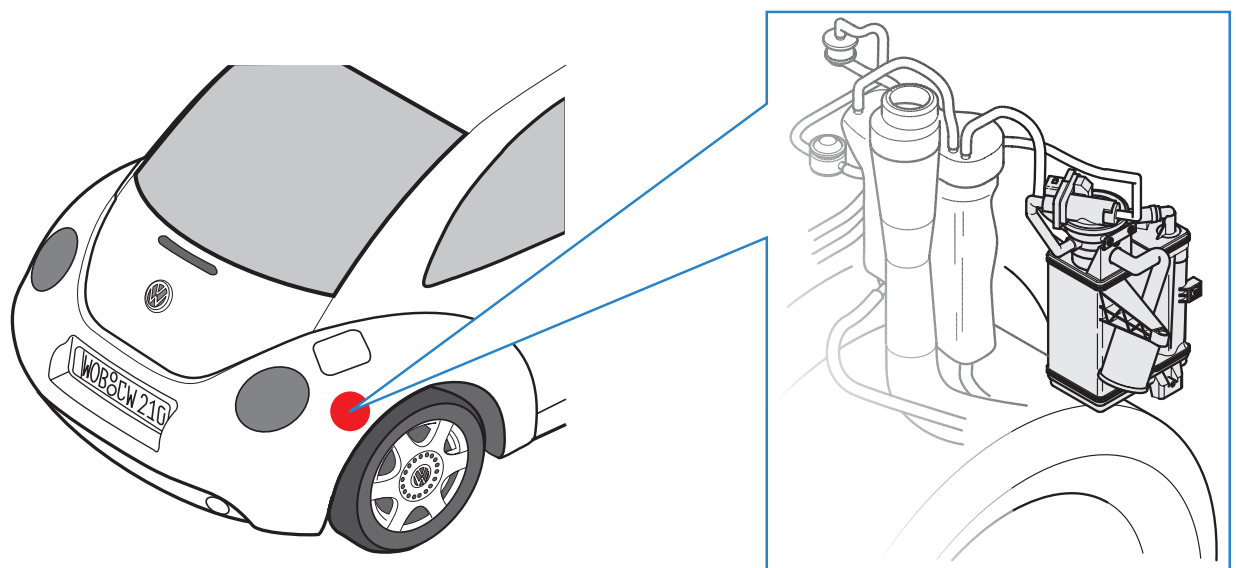

175_082

The OBD II checks:

- The function (flow rate) of activated charcoal filter system solenoid valve 1
- The function of electrical components (Comprehensive Components)

Procedure

When the tank ventilation system is activated, the fuel-air mixture is enriched by the additional gas flow if the activated charcoal canister is filled with vapors and leaned down if the tank is empty. This change in the fuel-air mixture is detected by the lambda probe and is therefore a criterion for the function test on the tank ventilation system.

Problem:

The diagnosis system reacts sensitively to disturbance variable feedforward (e.g. power steering, brakes or A/C on) during the diagnosis cycle.



Diagnosis by means of the lambda probe signal

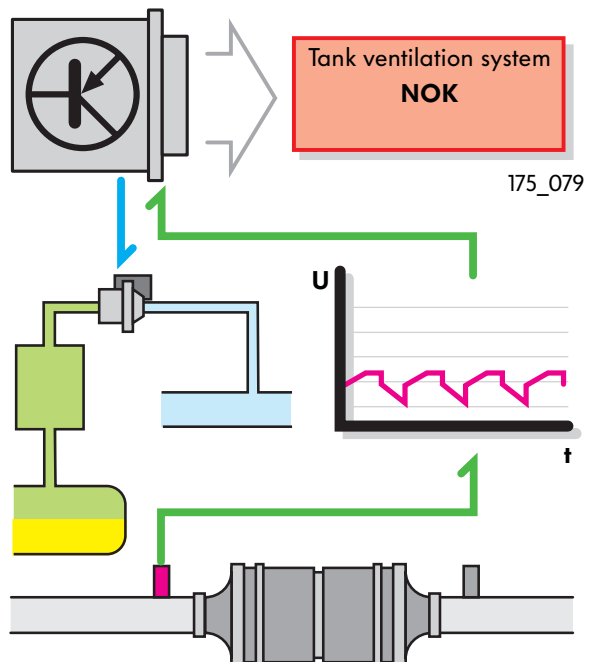
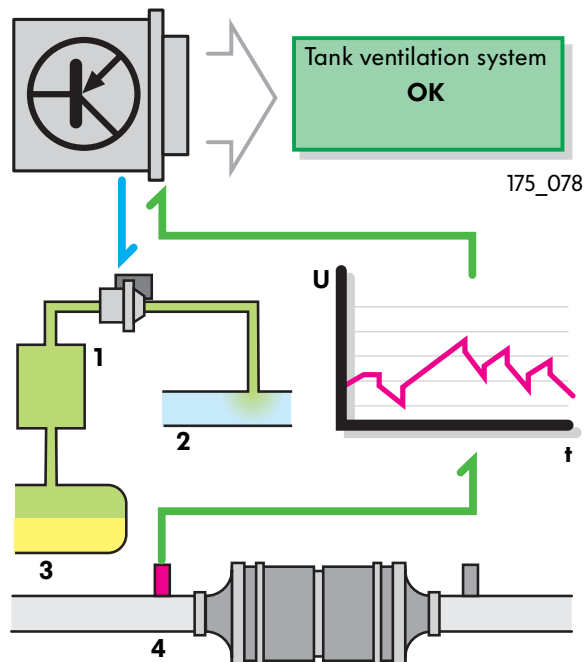

Legend:

- 1 Activated charcoal filter
- 2 Intake manifold

- 3 Tank
- 4 Primary catalytic converter probe

System Components (Gasoline Engine)

Activated charcoal filter system solenoid valve 1 N80

Installation position: located near to the air filter housing/suspension strut. It controls ventilation of the activated charcoal canister in the intake manifold and is colored black. In the deenergized state, it is closed.

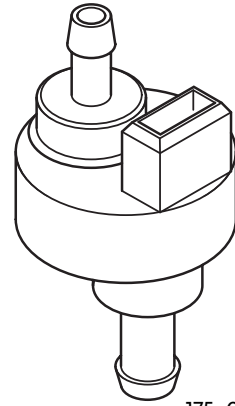

175_080

Electrical circuit

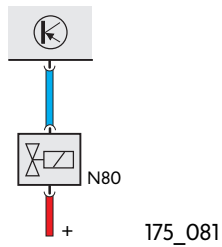

Leak diagnosis

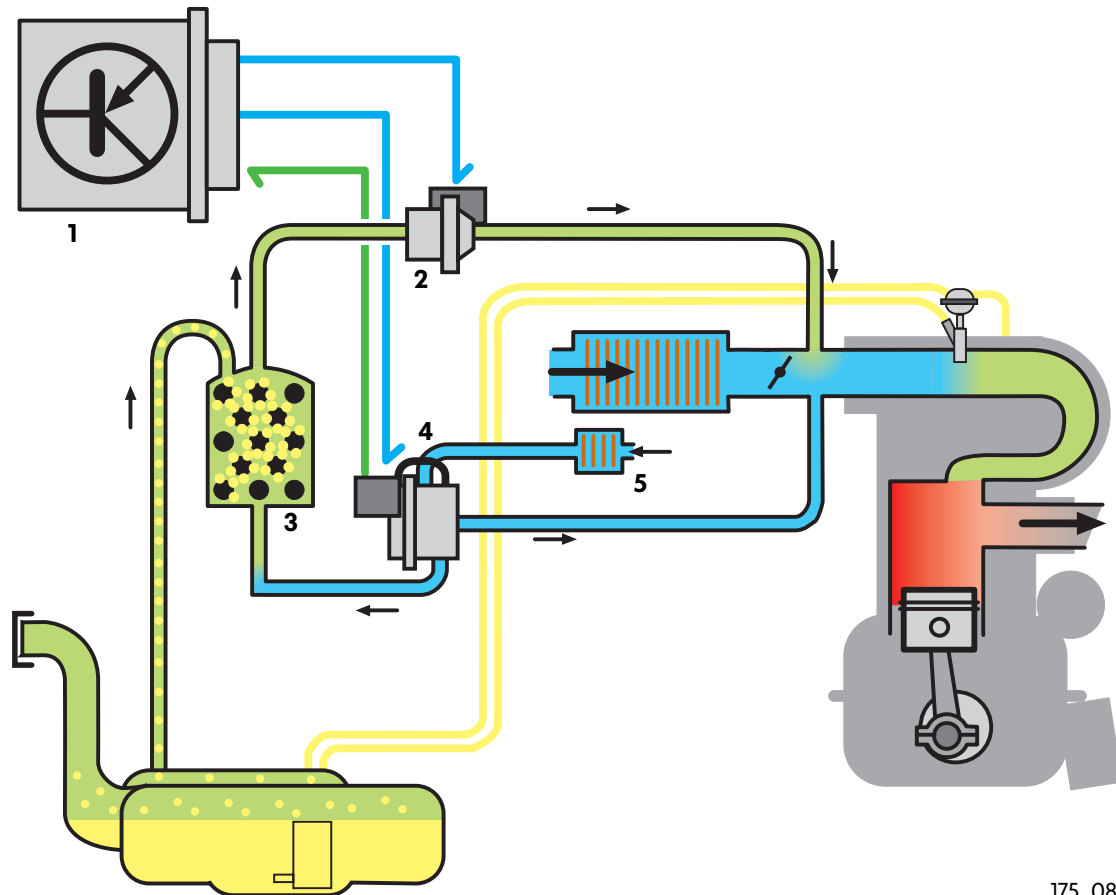

175_085

Legend:

- 1 Motronic control unit
- 2 Activated charcoal filter system solenoid valve 1
- 3 Activated charcoal canister
- 4 Fuel system diagnosis pump
- 5 Filter for diagnosis pump

The leak diagnosis is carried out for New Beetle (U.S.A.) as part of OBD II. It is based on the over-pressure method and indicates leaks with diameters greater than 1 mm.

For the diagnosis cycle, the tank system is disconnected from the intake pipe vacuum by activated charcoal filter system solenoid valve 1.

The fuel system diagnosis pump then builds up a defined excess pressure. The engine management system checks how quickly the pressure drops in the tank system to determine the leaktightness of the system.



System Components (Gasoline Engine)

Diagnosis of a minor leak

The test phase starts after the fuel system diagnosis pump in the tank system has built up an overpressure. The drop in overpressure is monitored at the same time.

A reed switch is coupled with a membrane in the fuel system diagnosis pump.

If the pressure in the tank system drops, the position of the membrane changes. If the pressure drops below a defined value, the reed switch closes and the pump increases the pressure again until the reed switch is reopened by the membrane.

The larger the leak, the quicker the succession of diagnosis pump delivery periods. This indicates a possible leak and the size of this leak.

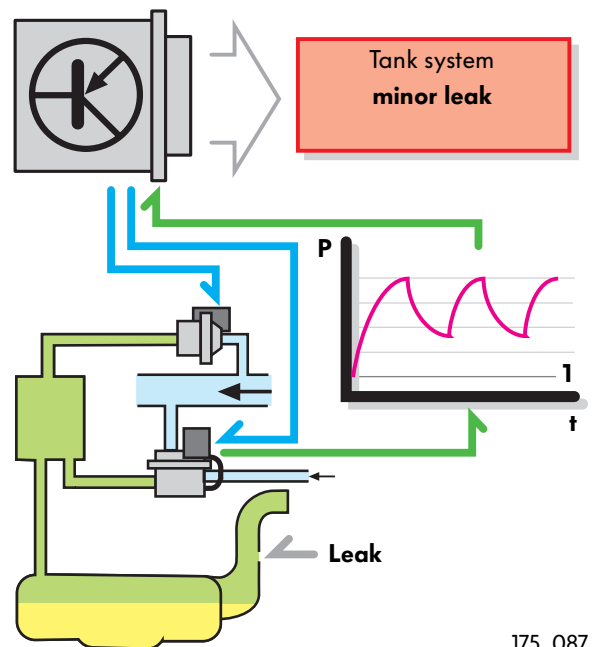
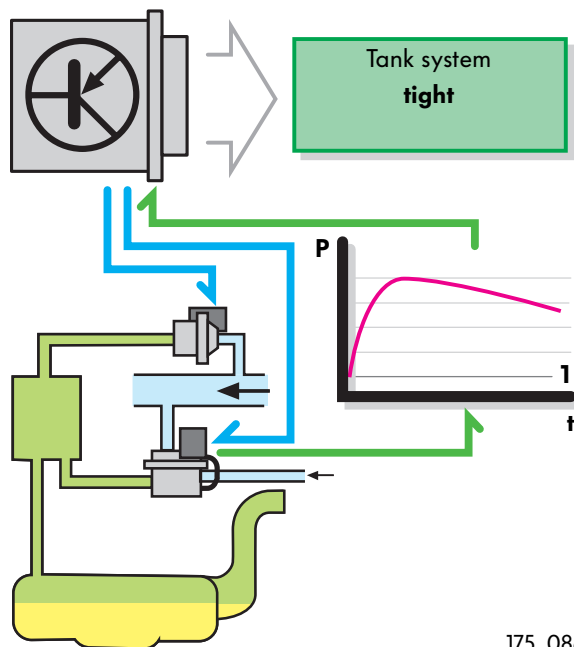

P = pressure, t = time

Diagnosis of a major leak

If the frequency of the delivery periods exceeds a certain value, or if the pump fails to build up the necessary pressure, the engine management system concludes that a major leak has occurred.



For example, this fault message can also be caused by forgetting to fit the fuel filler cap.

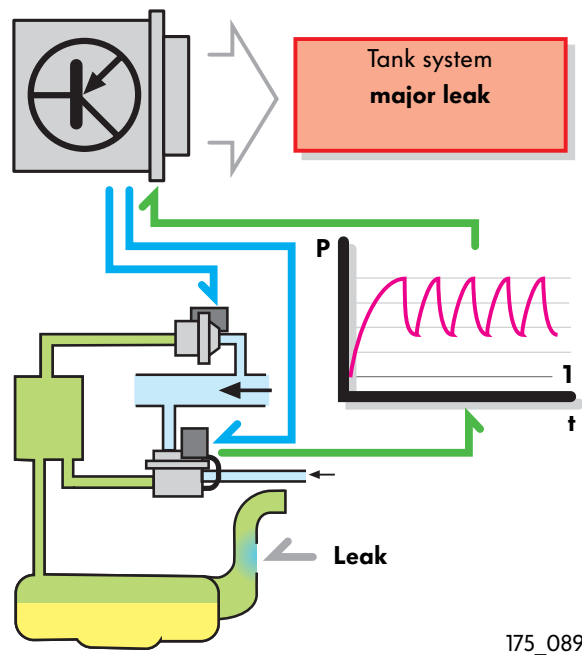
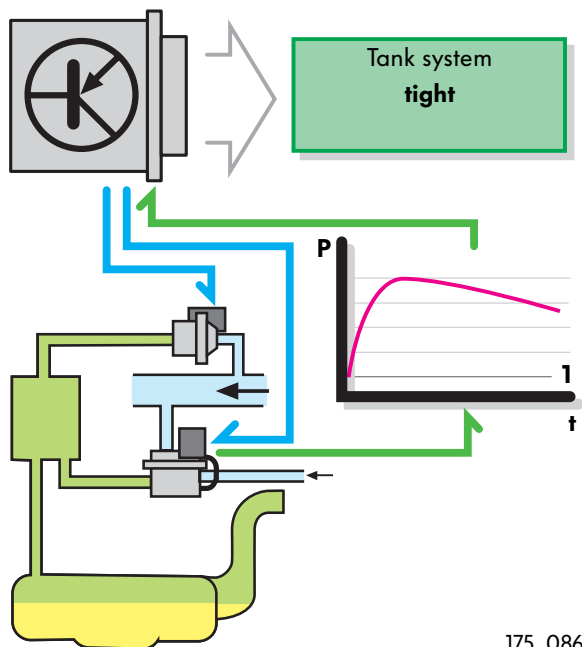
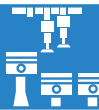

System Components (Gasoline Engine)

Fuel system diagnosis pump V144

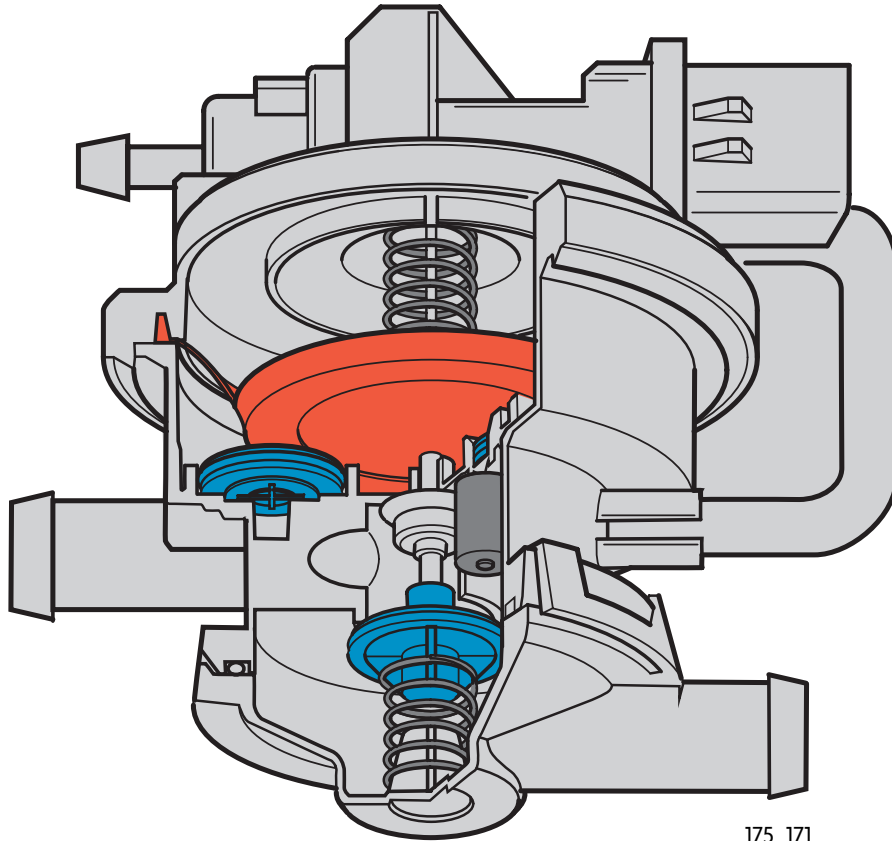

The fuel system diagnosis pump takes the form of a diaphragm pump. It is mounted at the ventilation connection of the activated charcoal canister (ACF) and contains an integrated ACF shut-off valve. The fuel system diagnosis pump is driven by the intake pipe vacuum via an internal vacuum switch.

The reed switch monitors the measurement sequence of the diagnosis pump. If the pressure inside the tank system drops below a defined value, the reed switch closes and the pump executes another diaphragm stroke causing the switch to reopen.

The diagnosis pump is activated after the cold start. This disables the fuel tank purging system function until the end of the leak diagnosis cycle.



The tank level does not affect the outcome of the diagnosis.

Function

Normal and ventilation position

The ACF shutoff valve is open in the lowest possible membrane position. The vacuum switch is closed, with the result that atmospheric pressure prevails above and below the membrane. The reed switch is closed.

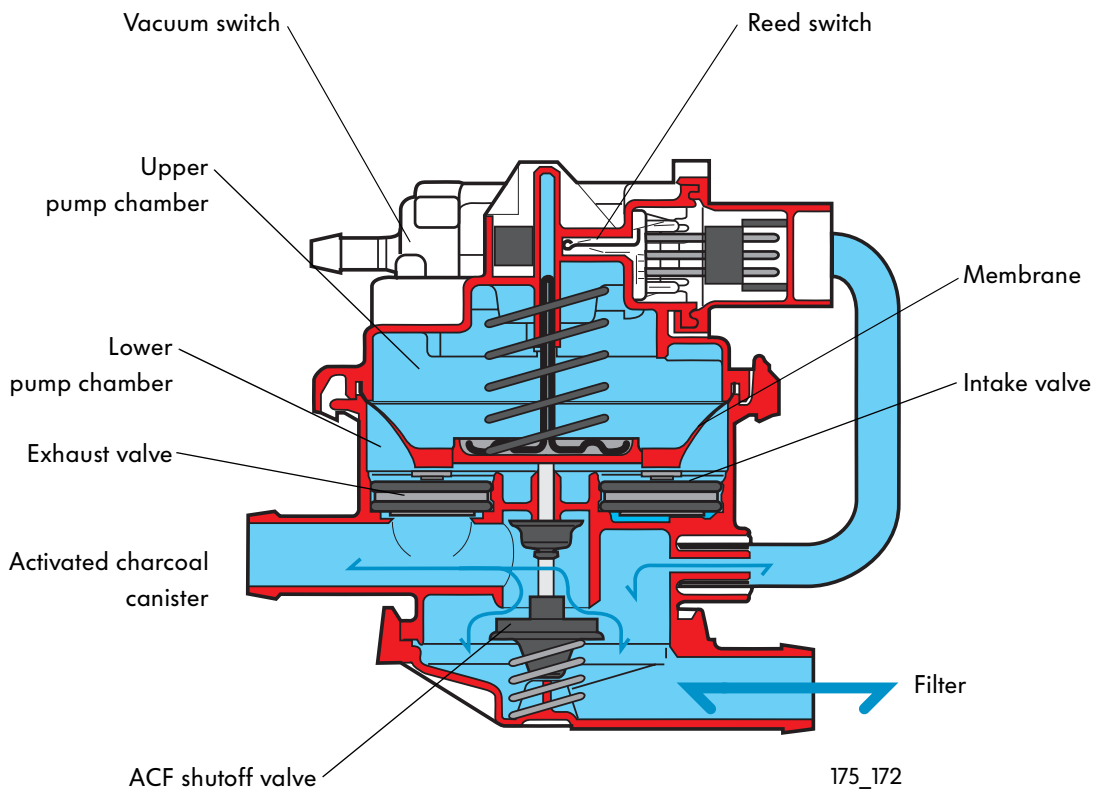

System Components (Gasoline Engine)

Upper membrane position

Opening the vacuum switch creates a vacuum above the membrane. Ambient air flows into the lower pump chamber through the intake valve. The membrane is raised by the outer air pressure. The reed switch opens.

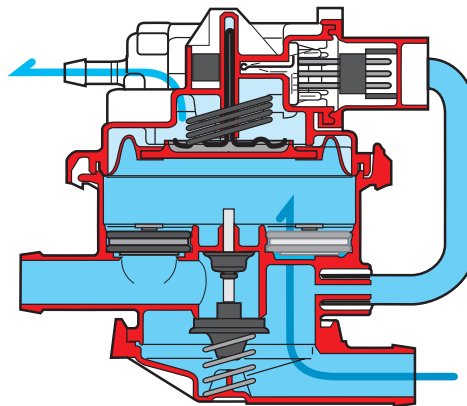

Lower membrane position when pump is in operation

Closing the vacuum switch allows ambient air to flow into the upper pump chamber. The membrane is pushed down by the spring and forces the air in the lower pump chamber into the tank system via the exhaust valve.

Before the membrane reaches the lowest position which would open the ACF shutoff valve, the reed switch closes and the membrane rises again.

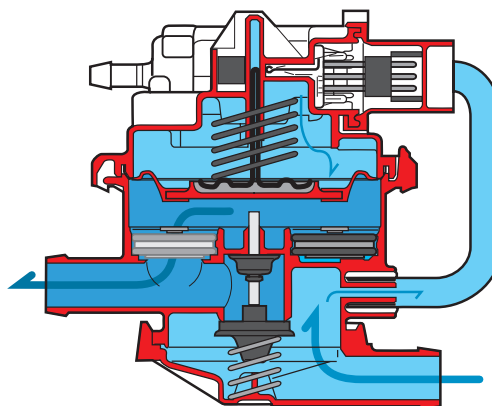

Fuel system diagnosis pump V144

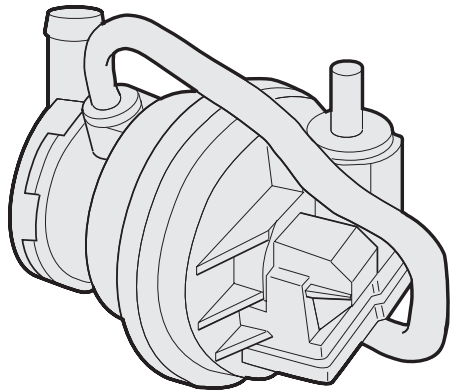

175_090

The OBD II checks:

- the mech. and electr. function of the fuel system diagnosis pump
- coupling of pump to fuel vapor retention system
- leak-tightness of complete fuel vapor retention system

Effects of signal failure

Without the reed switch, the Motronic control unit cannot determine whether the pump is functioning or not. A test phase does not take place.

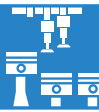

Electrical circuit

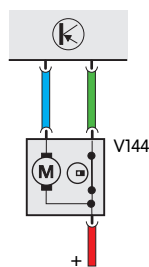

175_091



The fuel vapor retention system refers to all components which are located above the level of tank filling. It prevents fuel vapors escaping to the atmosphere.

System Components (Gasoline Engine)

The misfire detection system

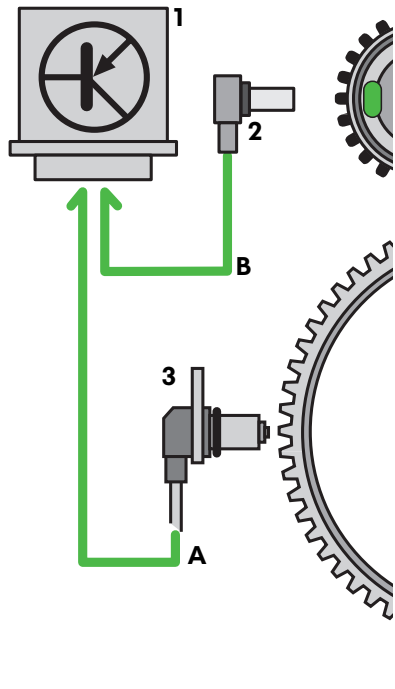

Cylinder-selective misfire detection:

Example: Cylinder 4 misfires

A Crankshaft signal:
possible misfiring on cylinder 1 or 4

B Camshaft signal:
Recognition of position of cylinder 1

Signal A+B
= misfiring on cylinder 4

175_095

Legend:

- 1 Motronic control unit
- 2 Hall sender
- 3 Engine speed sender

If a misfire occurs, the air-fuel mixture is discharged unburnt to the exhaust gas stream. In addition to loss of engine power and a deterioration in exhaust emission quality, the main hazard involves overheating or damage to the catalytic converter due to the increased catalytic combustion rate.

The basic principle of the misfire detection system is based on cylinder-selective detection of irregular engine running.

Road surface unevenness may be misinterpreted as misfiring. Therefore, the misfire detection system is switched off by the engine management system when severe road unevenness occurs.

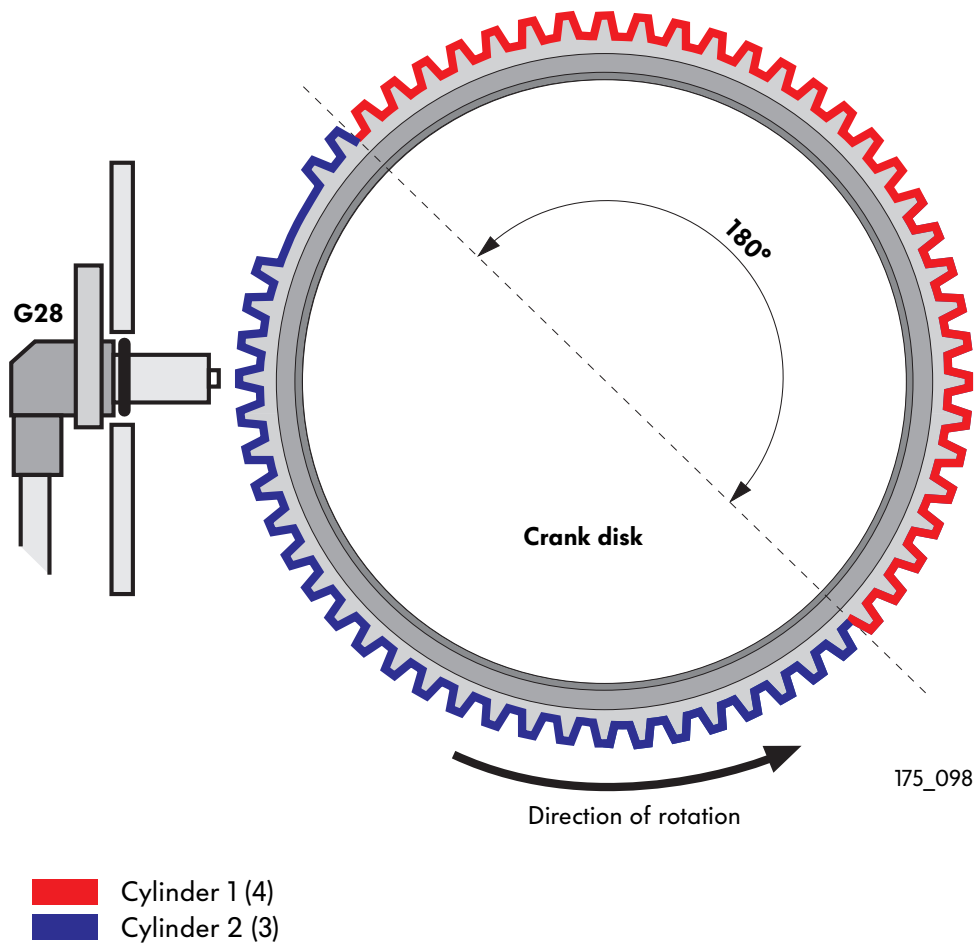

Cylinder-selective misfiring is detected and indicated by subdividing the crank disk (60-2 teeth) into two 180° segments in the 4-cylinder engine and incorporating the camshaft position signal.

To compensate for minor faults/tolerances at the sprocket gear, sender adaption takes place in the overrun phase when the vehicle is running.



System Components (Gasoline Engine)

The OBD II checks:

- the misfire rate continuously at defined measurement intervals of 1000 crankshaft revolutions. Exceeding the HC concentration by a factor of 1.5 is equivalent to a misfire rate of greater than 2%.
- the misfire rate within a 200 crankshaft revolution interval making allowance for boundary conditions (engine speed/engine load) in order to prevent catalytic converter damage.



Procedure:

Misfiring causes additional fluctuations in the running characteristics of the crankshaft. The Motronic M5.9.2 engine management system monitors the behavior of the crankshaft by means of the crank disk and engine speed sender G28.

Misfiring alters the circumferential speed of the crank disk.

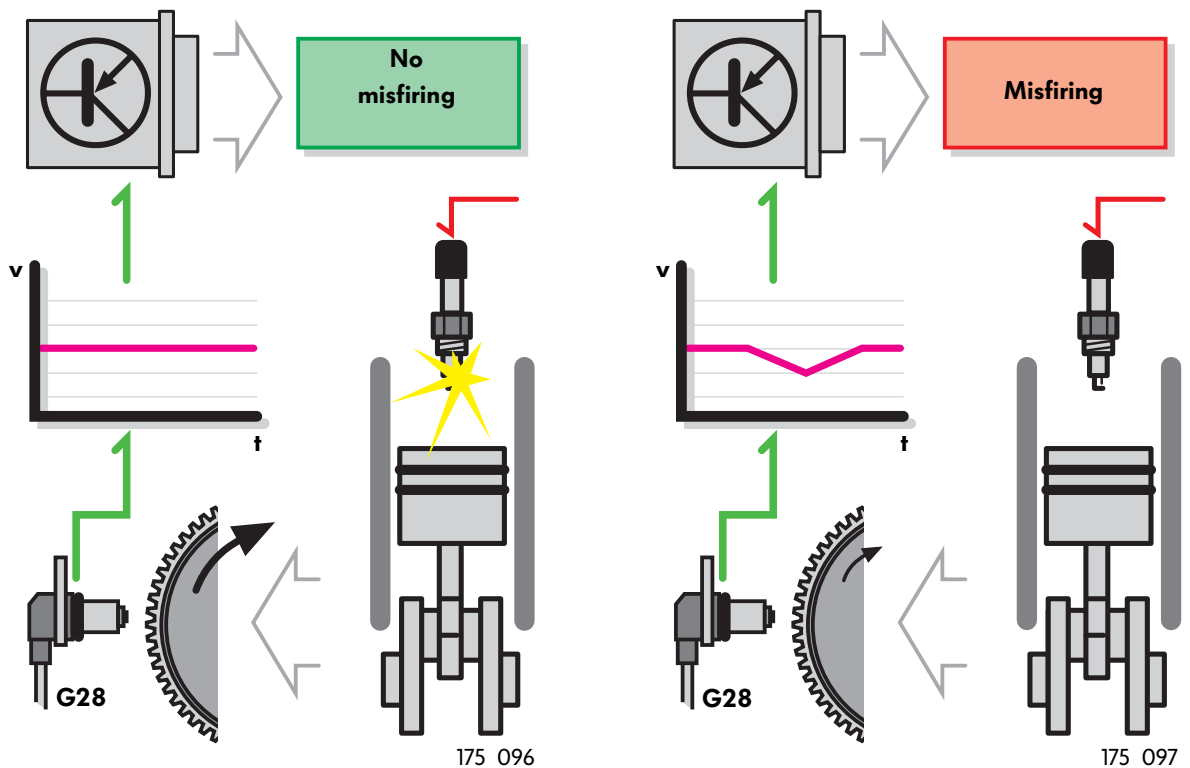

v = engine speed, t = time

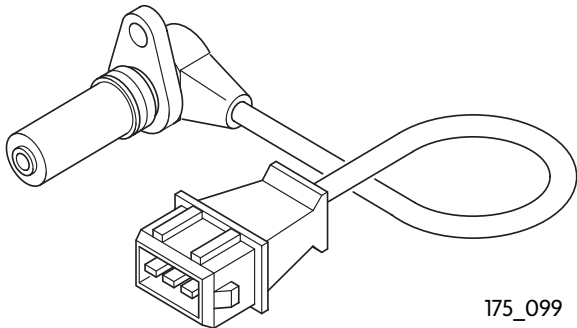

175_099

Electrical circuit

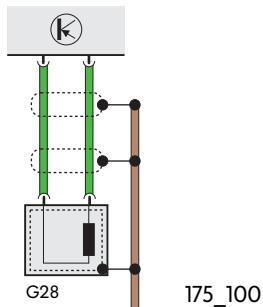

175_100

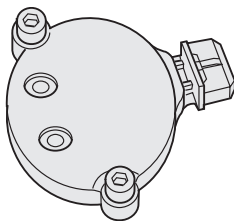

175_101

Electrical circuit

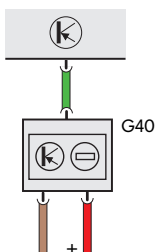

175_103

Engine speed sender G28

This inductive sender detects crankshaft rpm data and makes it possible to monitor the running characteristics of the engine.

The signal generated by the sensors is used to calculate:

- the fuel injection quantity and point,
- the ignition point, and
- engine speed.

Effects of signal failure

If the engine speed signal fails, the engine cannot be started.

If the fault occurs when the engine is running, the engine cuts out.

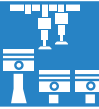

Hall sender G40

The signal generated by the Hall sender helps to detect cylinder 1.

In the New Beetle (U.S.A.), the Hall sender is designed as a camshaft sensor.

Effects of signal failure

Misfire detection is also possible if sensor G40 fails. For engine operation, the system retards the ignition advance angle as an emergency function.

System Components (Gasoline Engine)

Throttle valve control unit J338

Integrated in the throttle valve control unit in addition to driver's side throttle valve control are the idle speed control and the cruise control system (CCS) function.

By using this compact unit, components such as the idle speed stabilization valve and the electro-pneumatic control unit for CCS are no longer necessary.

The system detects deviations in idling characteristics as a result of aging, wear or air bleed points in the engine and compensates for them by adaption within specified boundaries.

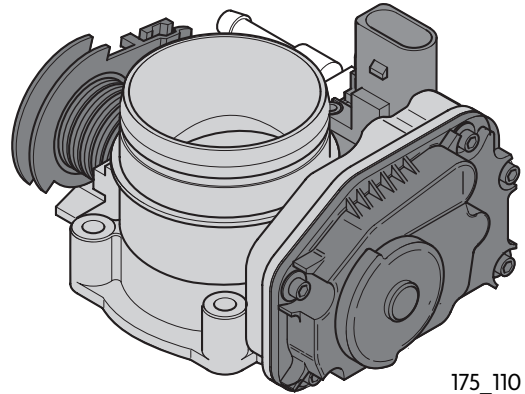

175_110



Faults in component parts of the throttle valve control unit cannot be remedied individually. If the unit malfunctions, it must be replaced.

The OBD II checks:

- the electrical function of the components and
- the function and limit of idle speed adaption.

Procedure:

The throttle valve control unit is monitored by the system within the framework of the Comprehensive Components Diagnosis. In addition, the values of the components are checked for plausibility.

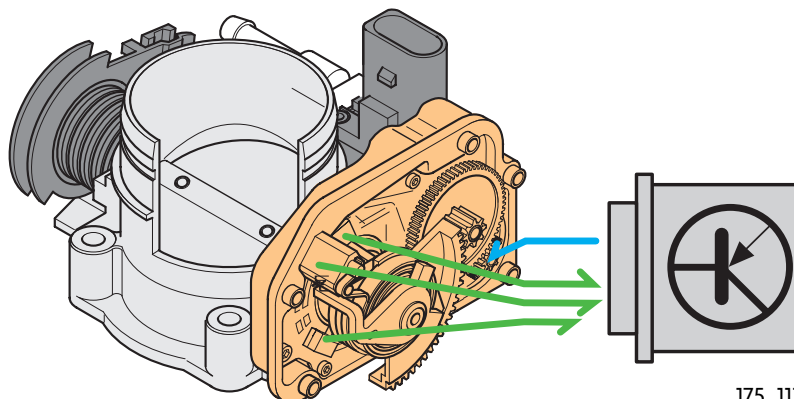

175_111

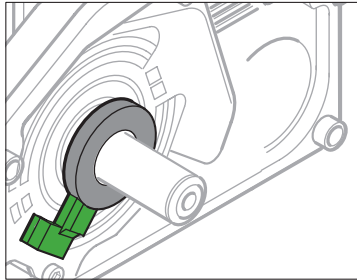

175_113

Electrical circuit

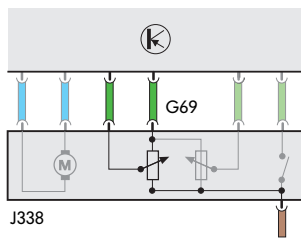

175_176

Throttle valve potentiometer G69

This potentiometer indicates the momentary position of the throttle valve over the full adjustment range to the Motronic control unit.

Effects of signal failure

If the Motronic control unit does not receive a signal from this potentiometer, it calculates a substitute value from the engine speed and the air-mass flow meter signal.

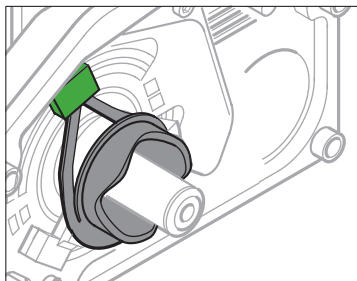

175_114

Electrical circuit

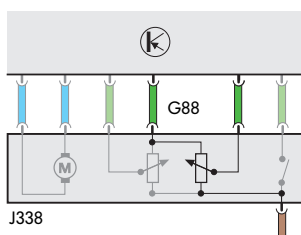

175_177

Throttle valve positioner potentiometer G88

It indicates the momentary position of the throttle valve positioner and sends this signal to the Motronic control unit.

Effects of signal failure

If this signal fails, the idle speed control goes to emergency mode. This can be identified by an increase in idling speed. The CCS fails.

System Components (Gasoline Engine)

Idling speed switch F60

The Motronic control unit detects from the closed idling speed switch that the engine is idling.

Effects of signal failure

If this signal fails, the control unit utilizes the values of the two potentiometers to detect when the engine is idling.

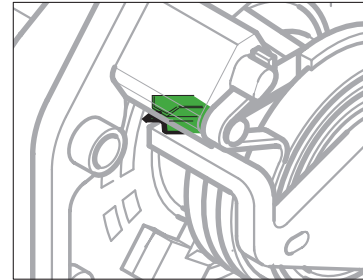

175_113

Electrical circuit

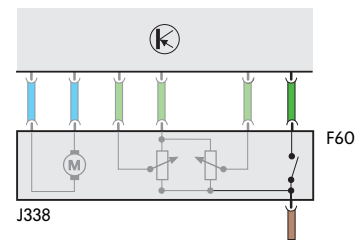

175_178

Throttle valve positioner V60

The throttle valve positioner is an electric motor which can actuate the throttle valve over the full adjustment range.

Effects of failure

The emergency running spring pulls the throttle valve into the emergency running position (increased idling speed).
The CCS fails.

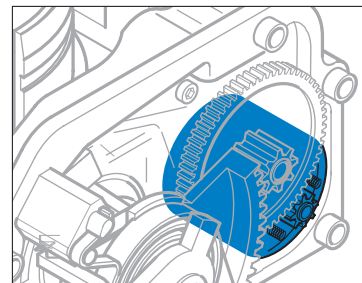

175_116

Electrical circuit

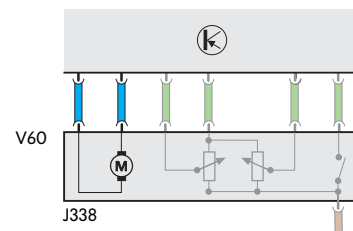

175_175

Air-mass flow meter G70

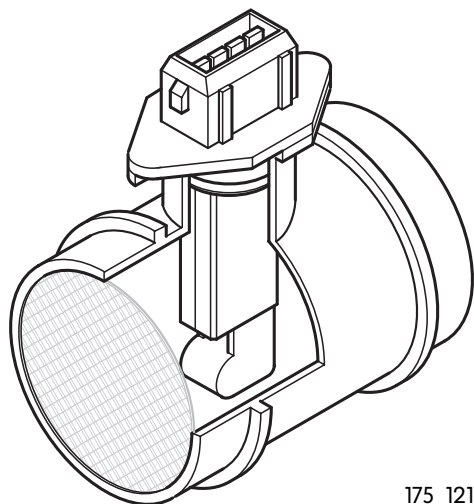

G70 supplies the Motronic control unit with information on how much air is induced by the engine. The control unit uses this data to optimize mixture composition and reduce fuel consumption by adapting the combustion process.

To maximize the accuracy of the information on induced air flow, the air-mass flow meter detects return flows which are caused by the opening and closing of the valves, and offsets them against the induced air flow.

The measured values of the air-mass flow meter are used to calculate all engine speed and load-dependent functions such as injection time, ignition point or tank ventilation system.

The OBD II checks:

- the electrical signal of the sensor,
- the values for plausibility.

Procedure:

The air-mass flow meter is monitored by the system as part of the Comprehensive Components Diagnosis. A faulty voltage is diagnosed as too high or too low.

In addition, the values are compared with a substitute value derived from the throttle valve position and engine speed.

Effects of signal failure

If the air-mass flow meter fails, the control unit calculates a substitute value. This “emergency function” is so well-adapted that it cannot be identified by a change in the engine's running characteristics.

Electrical circuit

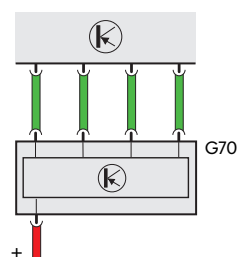

System Components (Gasoline Engine)

Static high-voltage distributor

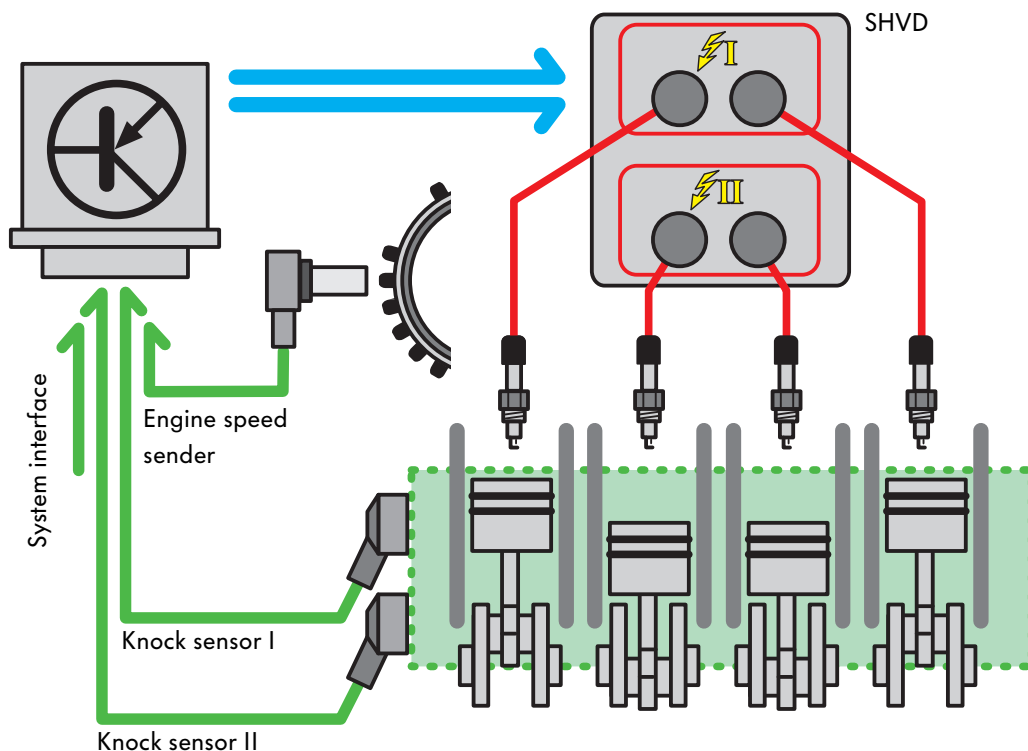

175_131

The static high-voltage distributor is a static ignition system which regulates the ignition point and the ignition voltage electronically. In the 4-cylinder engine, 2 spark plugs are activated simultaneously by two independent ignition coils.

This system also permits cylinder-selective detection and correction of knocking combustion.

To determine the correct ignition point, the signals generated by the knock sensors, the engine load signal, the coolant temperature signal and the engine speed signal are processed by the Motronic control unit. Using this data, the control unit can adapt the ignition point to any engine operating state. This improves engine efficiency, fuel consumption and emission behavior.

The OBD II checks:

- the electrical signal of the knock sensors.
- and the function of the ignition system via the misfire detection.

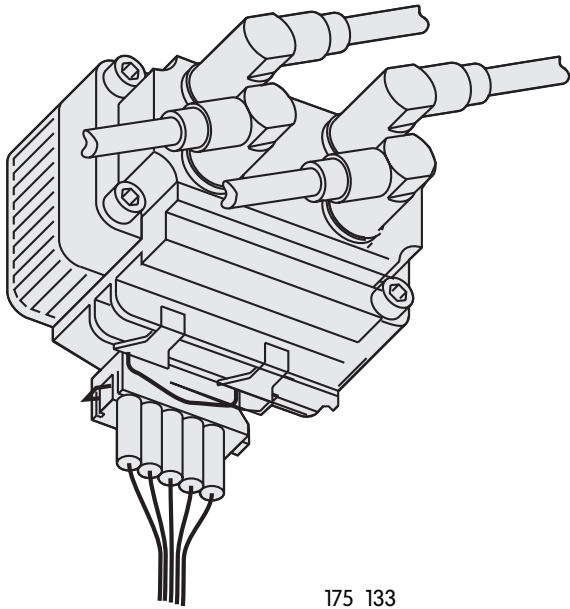

175_133

Procedure:

A higher incidence of misfires is a possible sign of a faulty ignition system. By following the diagnosis instructions, the fault can be narrowed down using the exclusion method.

Ignition transformer N152

Output stage N122 and ignition coils N and N128 are combined in ignition transformer N152. The ignition transformer is therefore the key element of the static high-voltage distributor.

It is located below the secondary air pump motor attached to its own holder.

The layout of the high-voltage cable is marked on the coil housing.



Electrical circuit

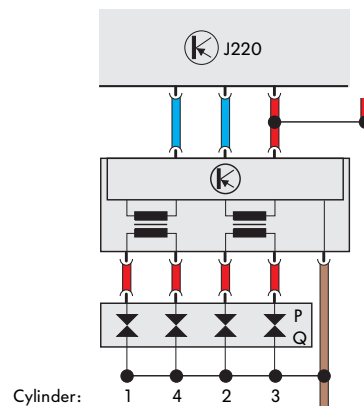

Cylinder:

175_134

System Components (Gasoline Engine)

Knock sensors G61 and G66

Electronic control of the ignition point is superimposed on cylinder-selective knock control. Cylinder-selective assignment of knock signals is by means of the Hall sender which recognizes the first cylinder and the position of the crankshaft.

After a knocking cylinder is detected, the ignition advance angle of the cylinder in question is retarded incrementally until knocking is eliminated.

Effects of signal failure

If G61 fails, the ignition advance angle for all cylinders is retarded and the mixture is enriched.

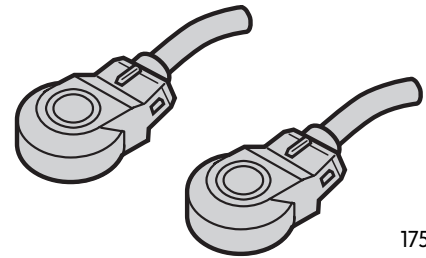

175_137

Electrical circuit

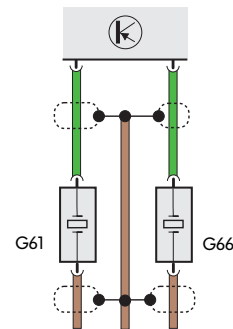

175_138

Injectors N30, N31, N32, N33

The injectors with vertical fuel feed are secured to a common fuel manifold by means of securing clip.

Power is supplied by a thermal trip.

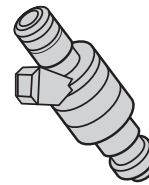

175_143

Electrical circuit

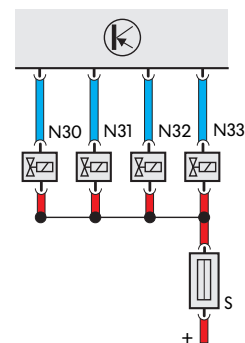

175_144

Motronic control unit J220 (M5.9.2)

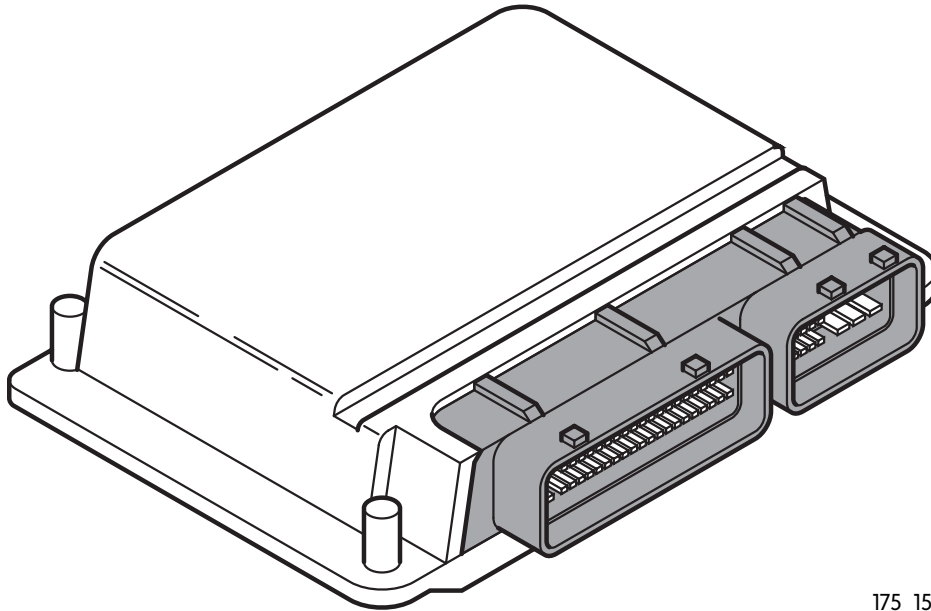

175_151

The Motronic control unit is integrated in the plenum chamber and controls all engine management functions.

The Motronic control units in version M5.9.2 include all the functions of On-Board Diagnosis System II and meet the legal requirements of the CARB.

The control unit indicates malfunctions by the self-diagnosis fault warning lamp (MIL).



System Components (Gasoline Engine)

Other monitored sensors

Speedometer sender G22

The installation position of the speedometer sender is on the transmission housing. It records the vehicle road speed.

Effects of signal failure

If the signal fails, the speed limiting device cuts in early. This may cause the driver problems in handling the vehicle.

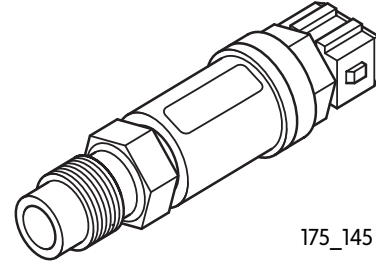

175_145

Electrical circuit

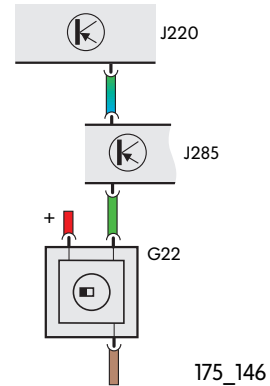

Coolant temperature sender G62

The coolant temperature sender is located in the coolant outlet hose at the cylinder head. Its signal also influences a wide range of functions of the ignition and injection systems.

Effects of signal failure

If G62 fails, the system computes a substitute value from the intake pipe temperature and other engine operating conditions.

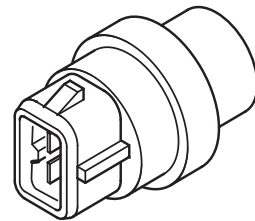

175_149

Electrical circuit

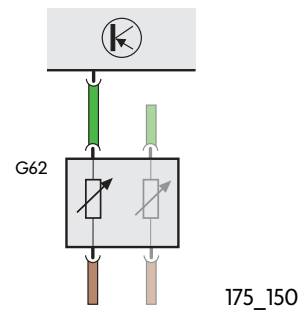



Overview of OBD-II (Diesel)

Basic concept of OBD-II (diesel)

Differences with OBD-II (gasoline engine)

In parallel to pollution control and monitoring in the gasoline engine, the diesel engine also has low-pollution components. These components are monitored via OBD-II.

The objectives and requirements relating to OBD-II (diesel) are identical to those for the OBD-II (gasoline engine), with the exception that different components are monitored due to the different combustion processes which take place.

OBD-II (Diesel) monitors the following components and systems:

- Misfire detection system
- Exhaust gas recirculation
- Injection commencement control
- Charge pressure control
- CAN bus
- Diesel direct injection system control unit
- All sensors and actuators relevant to exhaust emissions which are connected to the control unit
- Automatic transmission



OBD II

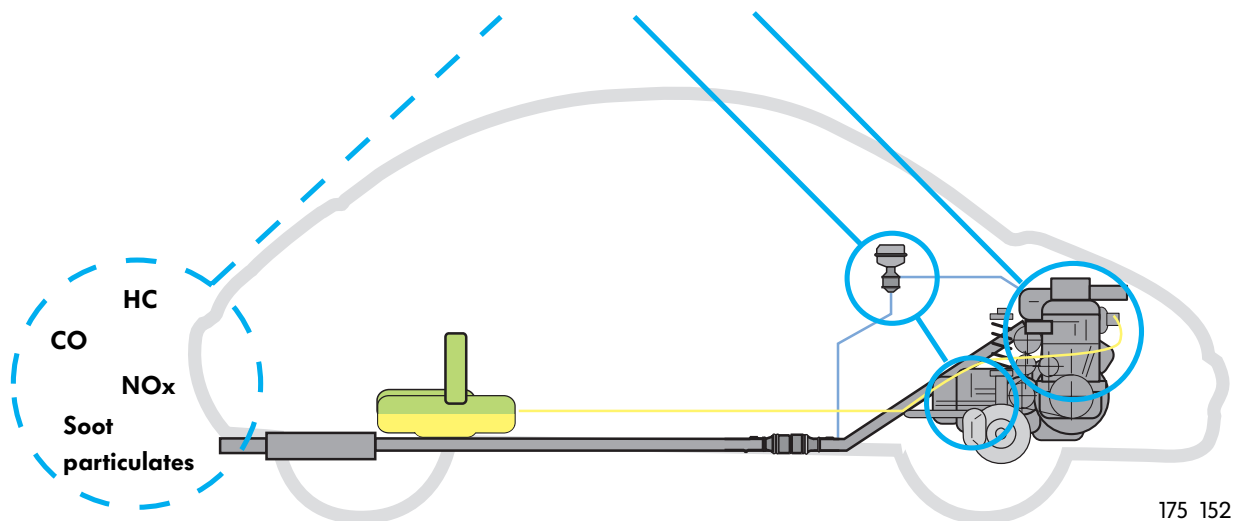

175_152

Emission limits for diesel vehicles

In addition to the previously mentioned pollutant emissions of gasoline vehicles, a further limit value must be observed in the case of diesel vehicles – the amount of soot particulates (PM).

We will illustrate this by quoting two examples of emission limits. Given that different test methods are used, the values cannot be compared with one another.

- The limit values for passenger cars which are approved for max. 12 persons applicable in the U.S. Federal State of California with effect from model year 1999.

The limit values conform to the TIER1 approval level.

- The emission limits currently applicable in the Federal Republic of Germany comply with the D3 standard.



Pollutant	Durability [mi]	Limit value MY '99 [g/mi]
NMHC	50,000	0.25
	100,000	0.31
CO	50,000	3.4
	100,000	4.2
NO _x	—	—
	100,000	1.0
Particulates	50,000	0.08
	—	—

175_044

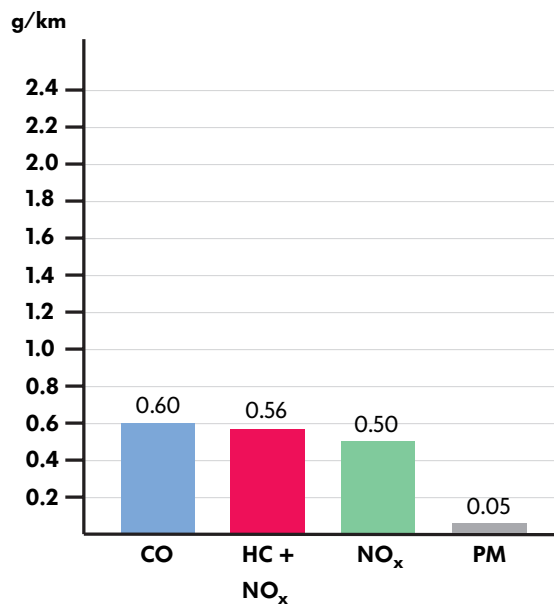

175_156

NMHC (Non-Methane Hydrocarbon) are hydrocarbons which do not contain any methane fractions.

Overview of OBD-II (Diesel)

System components

1.9-liter TDI

Legend

- 01** Diesel direction injection system control unit J248
- 02** Self-diagnosis fault warning lamp K83 (MIL) (communication from model year 2000 via the CAN bus)
- 03** Glow period warning lamp K29 (communication from model year 2000 via the CAN bus)
- 04** Air-mass flow meter G70
- 05** Exhaust gas turbocharger with charge pressure control valve
- 06** Charge pressure control solenoid valve N75
- 07** Intake manifold pressure sender G71 with intake manifold temperature sender G72
- 08** EGR valve
- 09** Exhaust-gas recirculation valve N18
- 10** Injector with needle lift sender G80
- 11** Glow plugs (engine) Q6
- 12** Glow plug relay J52
- 13** Engine speed sender G28
- 14** Coolant temperature sender G62
- 15** Distributor injection pump with modulating piston movement sender G149 Fuel temperature sender G81 Quantity adjuster N146 Commencement of injection valve N108
- 16** Accelerator position sender G79 with kick-down switch F8 Idling speed switch F60
- 17** CAN bus (communication with transmission control unit and with dash panel insert from model year 2000)
- 18** Diagnosis plug connection

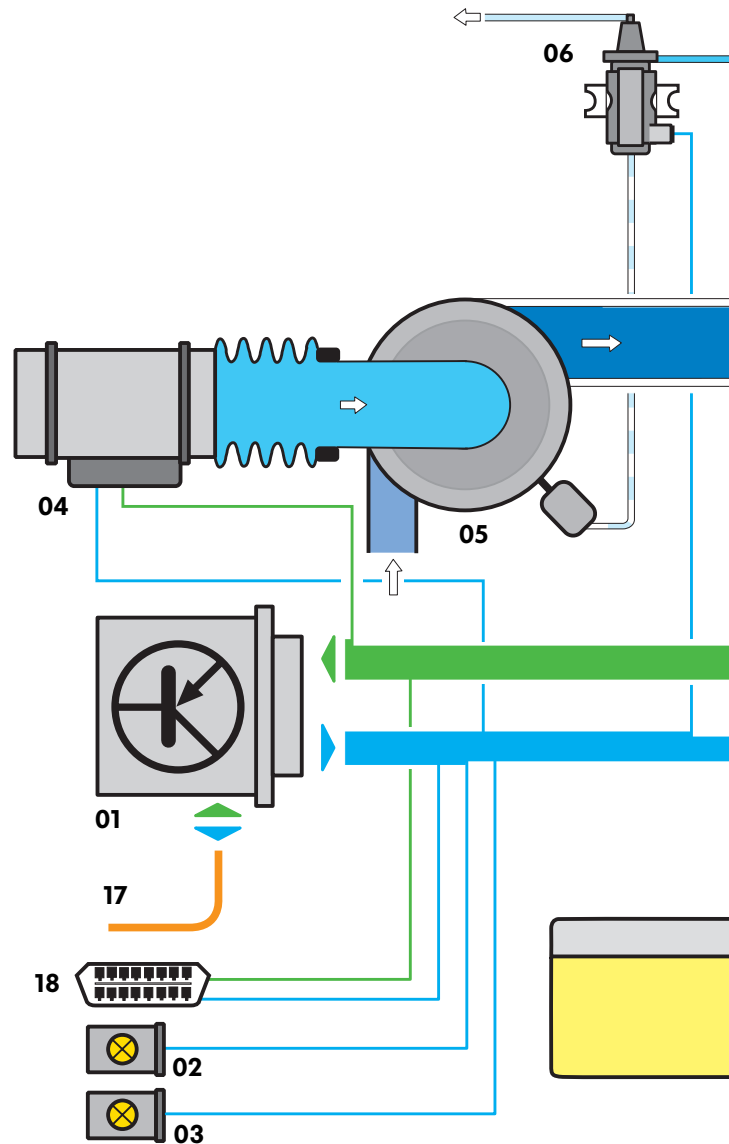

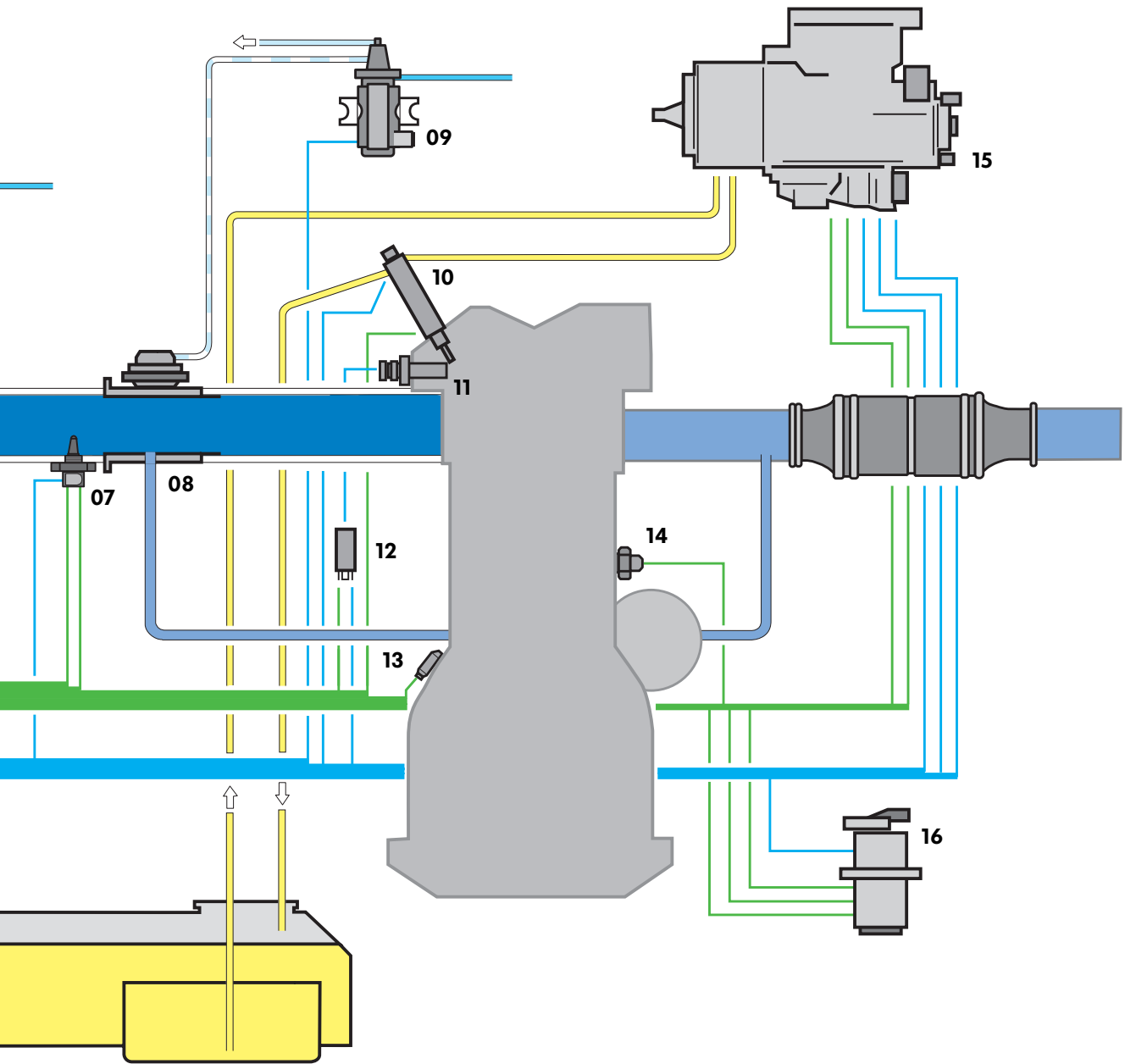

175_159

System Overview (Diesel)

Sensors

Air-mass flow meter **G70**

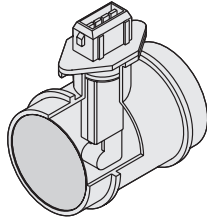

Accelerator position sender **G79**
with kick-down switch **F8**
Idling speed switch **F60**

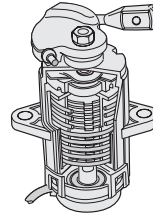

Engine speed sender **G28**

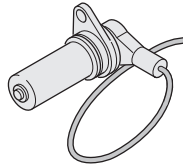

Needle lift sender **G80**

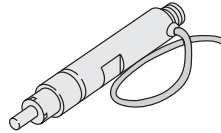

Coolant temperature sender **G62**

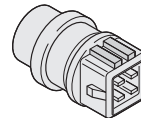

Intake manifold pressure sender **G71**
Intake manifold temperature sensor **G72**

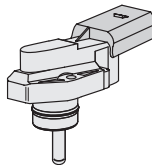

Modulating piston movement sender **G149**
Fuel temperature sender **G81**

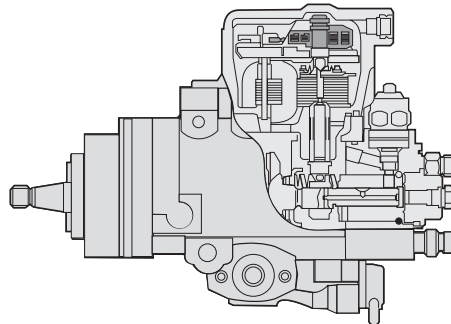

Glow plug relay **J52**

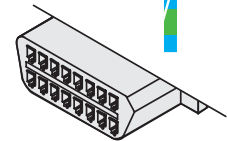
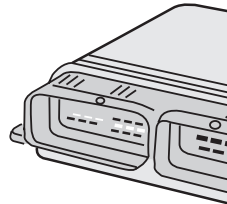

Diagnosis interface



Diesel direct injection system control unit **J248**

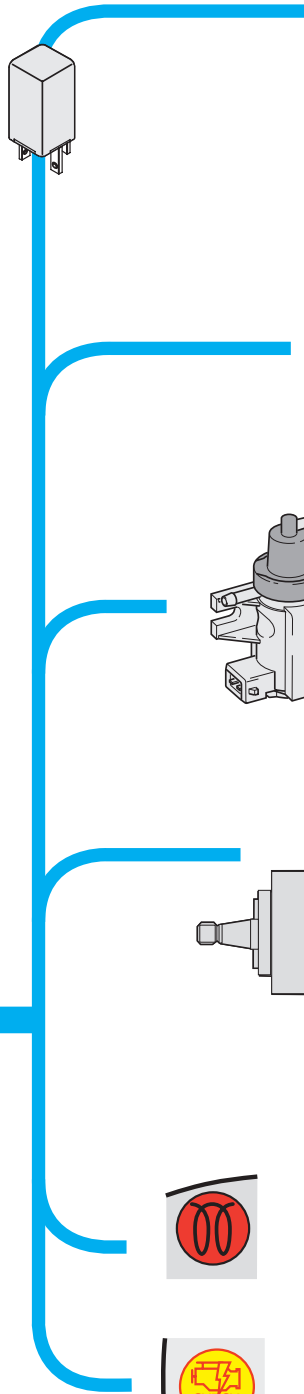
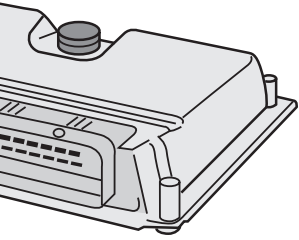

Actuators

Glow plugs (engine) **Q6**

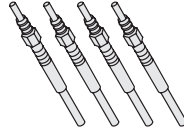

Glow plug relay **J52**

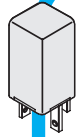

EGR valve **N18**

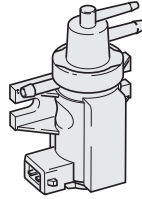

Charge pressure control solenoid valve **N75**

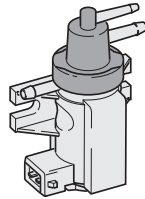

Quantity adjuster **N146**
Commencement of injection valve **N108**

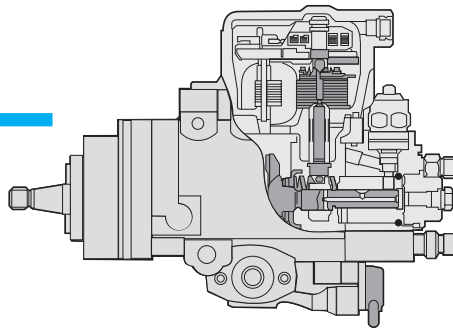

CAN bus



Glow period warning lamp **K29**
(communication via CAN bus from model year 2000)



Self-diagnosis fault warning lamp **K83** (MIL)
(communication via CAN bus from model year 2000)

175_181



System Components (Diesel)

The oxidation catalytic converter

In diesel engines, it is not possible to use a 3-way catalytic converter as in the gasoline engine. The reason for this is the excess air which is required to burn the fuel. As a result, the exhaust gases contain a high oxygen concentration which prevents the use of 3-way catalytic converters.

As the name already suggests, the oxidation catalytic converter can only transform pollutants in the exhaust gases by oxidizing them. This means that the nitrogen oxides (NO_x) cannot be converted by reduction as in the gasoline engine. The exhaust gas recirculation system was introduced nevertheless to limit the emission of nitrogen oxides.

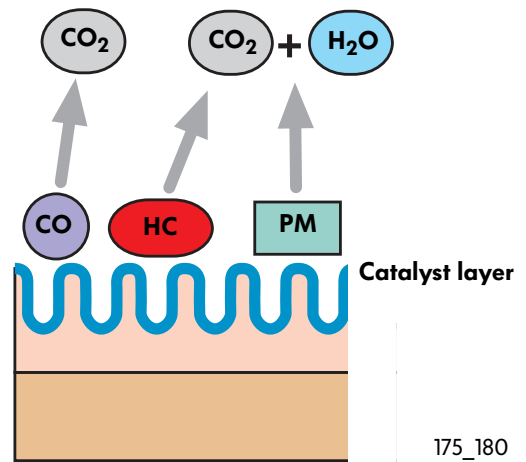

The design of the oxidation catalytic converter is very similar to the design of the 3-way catalytic converter, with the exception that the lambda probes are missing. In the oxidation catalytic converter, the exhaust gas must also flow through small ducts and, as a result, it passes over the active catalyst layer.

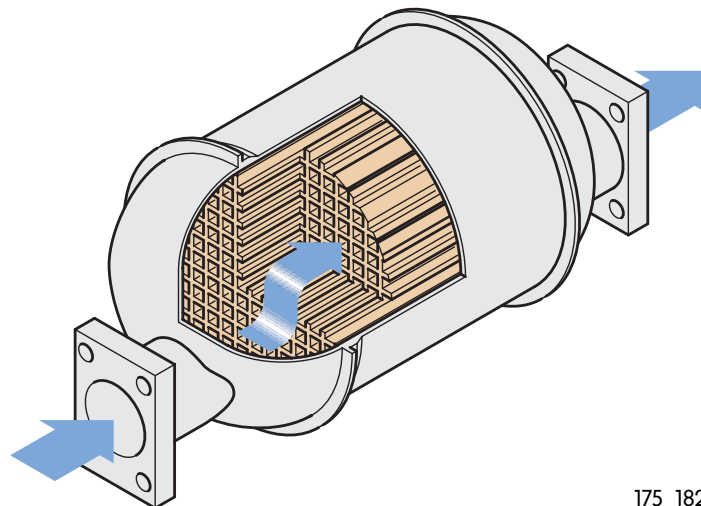

Injection commencement control

To optimize engine performance and smooth running refinement while simultaneously achieving low-emission combustion in all driving situations, the fuel injection point has to be adjusted continuously.

Various states of the engine or of diesel direct injection system control unit require an earlier injection point for optimum combustion:

- Cold start
- Increase in engine speed
- Increase in injection quantity

For calculating the nominal injection point, the diesel direct injection system control unit utilizes the engine speed, the coolant temperature and the calculated injection quantity. Using this calculated setpoint and making allowance for the measured actual value of the needle lift sender, the system sets the injection point via the commencement of injection valve.

The OBD II checks:

- the actual point of commencement of fuel injection by means of the needle lift sender
- the electrical function and signal plausibility of the engine speed sender, coolant temperature sender and needle lift sender
- the electrical function of the commencement of fuel injection valve

Procedure:

The diesel direct injection system control unit compares the signal generated by the needle lift sender (actual point of commencement of fuel injection) with specified values. These values are saved for the calculation in a map for each driving situation within the control unit.

Legend:

- 1 Diesel direct injection system control unit
- 2 Engine speed sender
- 3 Sender wheel
- 4 Coolant temperature sender
- 5 Needle lift sender
- 6 Commencement of injection valve
- 7 Calculated injection quantity

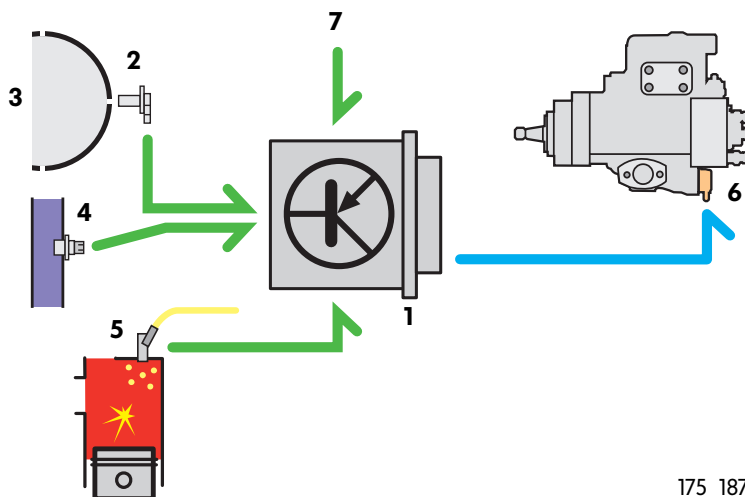

175_187



System Components (Diesel)

Engine speed sender G28

The sender acquires engine speed data in conjunction with the sender wheel on the crankshaft. This data is used to make several calculations within the control unit.

For example:

- Calculation of injection quantity and commencement of injection
- Cylinder-selective misfire detection
- Charge pressure control

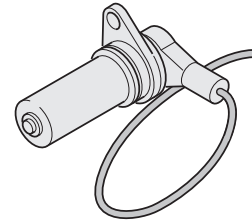

175_192

Effects of failure

If the signal fails, the engine is turned off and cannot be restarted.

Electrical circuit

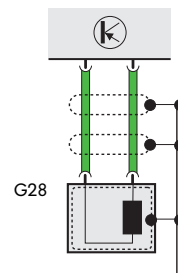

175_200

Needle lift sender G80

The following systems require the sender signal:

- Injection commencement control
- Cylinder-selective misfire detection

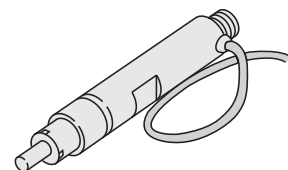

175_193

Effects of failure

If the sender fails, the point of commencement of injection is controlled via the stored map only. The injection quantity is reduced.

Electrical circuit

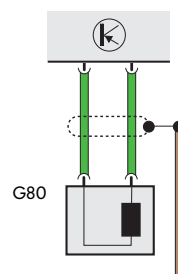

175_201

Commencement of injection valve N108

The diesel direct injection system control unit computes the required point of commencement of injection and activates the commencement of injection valve accordingly. The valve converts the input signal to a control pressure which acts on the injection timing piston within the distributor injection pump.

Electrical circuit

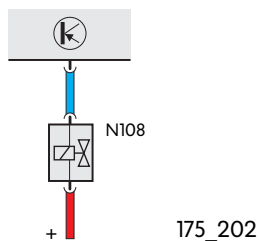

Effects of failure

The injection commencement control fails. The commencement of injection is controlled by means of a characteristic curve stored in the control unit.

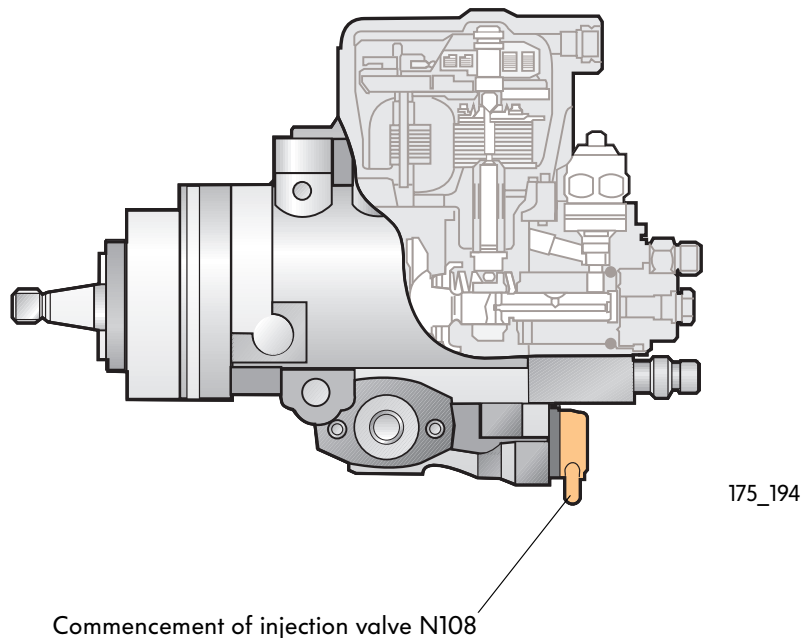

System Components (Diesel)

The exhaust gas recirculation system

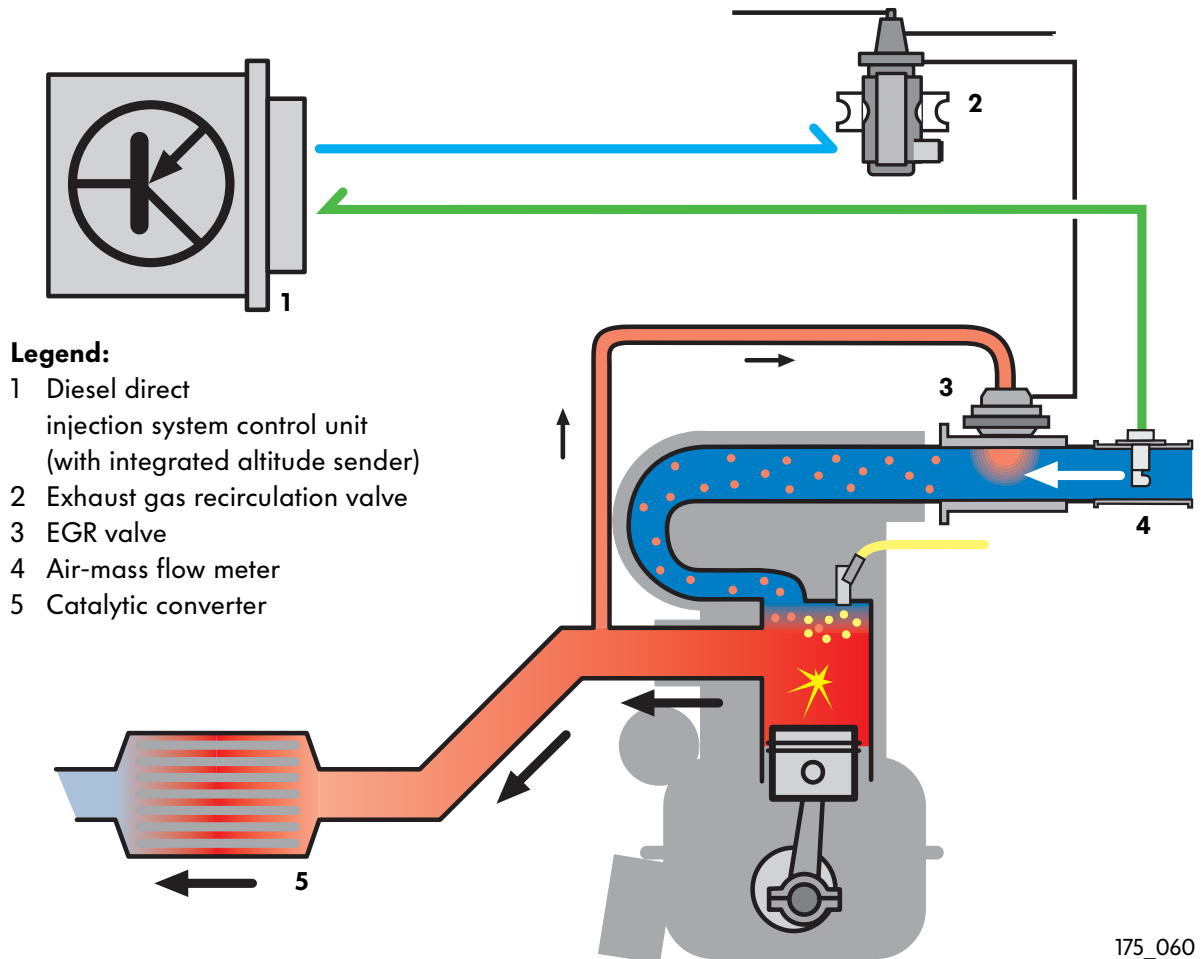

The direct injection process operates at high combustion temperatures and using high oxygen components which promote the formation of nitrogen oxides (NO_x). However, the resulting nitrogen oxides cannot be reduced by the oxidation catalytic converter. Their production must be reduced by using an exhaust gas recirculation (EGR) system.

If a certain amount of exhaust gas is added to the fuel-air mixture, the combustion temperature is reduced, the oxygen content in the combustion chamber is lowered and NO_x emission is reduced. The emission characteristics can be

controlled depending on load conditions through the controlled addition of exhaust gas.

The exhaust gas recirculation rate is limited by the rise in hydrocarbon (HC), carbon dioxide (CO) and particle emissions.

The OBD II checks:

- the opening and closing functions of the EGR valve by the air-mass flow meter
- Electrical function of the exhaust gas recirculation valve, altitude sender and air-mass flow meter

Exhaust gas recirculation inactive

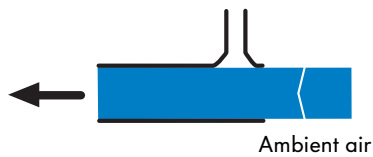

Exhaust gas recirculation active

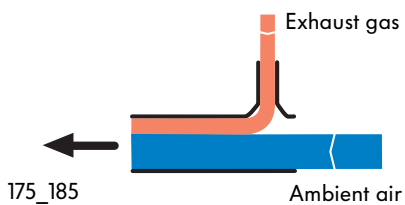

Procedure:

The function of the exhaust gas recirculation system is tested by the diesel direction injection system control unit (EDC 15V) by means of the air-mass flow meter. The air mass flow is monitored when exhaust gas is fed in and compared with setpoints in the control unit making allowance for the signal generated by the altitude sender.

The basic principle of the function check requires that the air mass flow rate (ambient air) during exhaust gas feed be less than when the exhaust gas recirculation system is switched off.

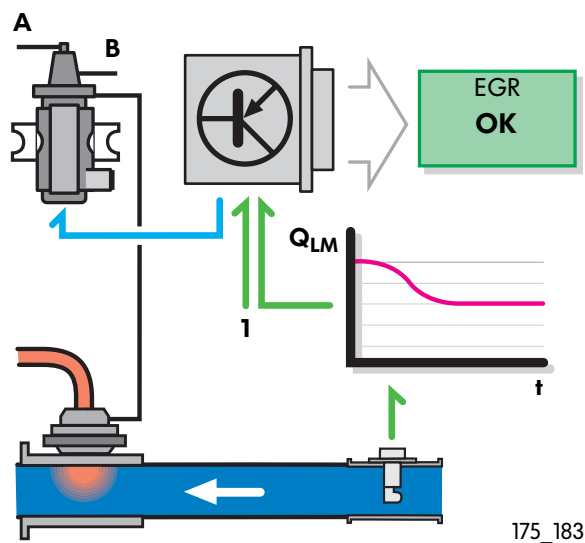

Q_{LM} = air mass flow, t = time
1 = signal from integrated altitude sender

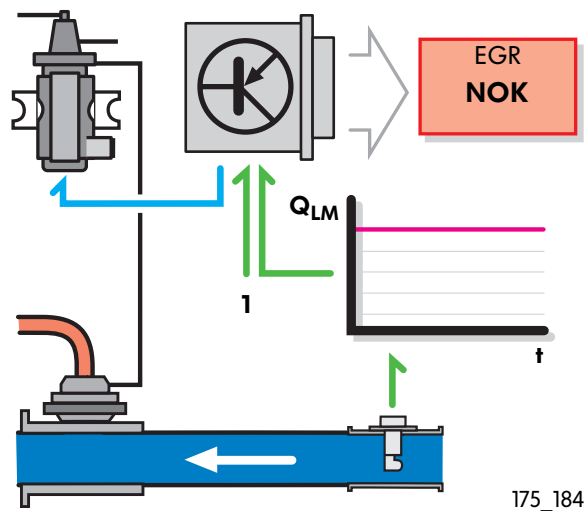

a = Vacuum
b = Atmospheric pressure



System Components (Diesel)

Exhaust gas recirculation valve N18

This valve converts the signals generated by the diesel direct injection system control unit to a control pressure. For this purpose the exhaust gas recirculation valve is supplied with partial pressure by the engine and transfers this to the EGR valve if the control unit generates a corresponding signal. The pulse duty factor of the control signal defines the magnitude of the exhaust gas recirculation rate.

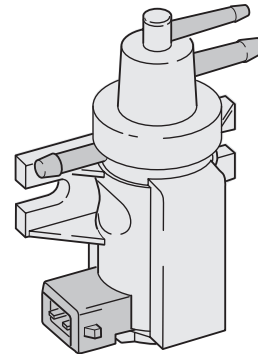

175_186

Effects of failure

If the valve fails, the exhaust gas recirculation system is shut down.

Electrical circuit

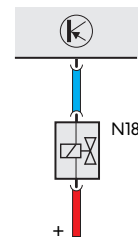

175_202

EGR valve

The EGR valve, together with the intake manifold flap, is integrated in the intake pipe.

When the EGR valve is subjected to vacuum by the exhaust gas recirculation valve, it opens and lets exhaust gas enter the intake manifold.

The EGR valve is not electrically activated and therefore cannot be checked directly for correct function.

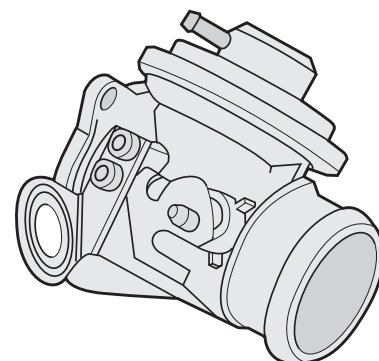

175_188

The misfire detection system

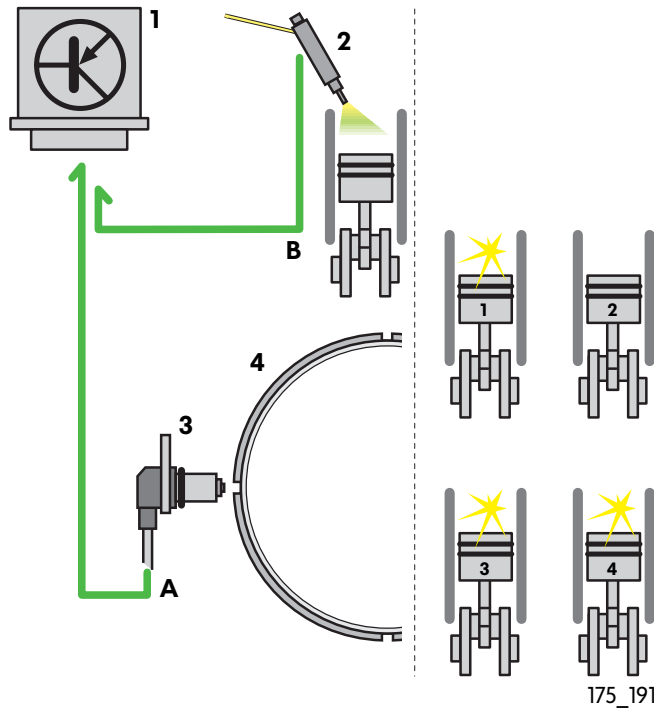

Cylinder-selective misfire detection:

Example: Misfiring on cylinder 2

- A** Crankshaft signal:
Misfire detected,
TDC signal for cylinders 1-4
- B** Needle stroke signal:
Recognition of position of cylinder 3

Signal A+B
= misfiring on cylinder 2

Legend:

- 1 Diesel direct injection system control unit
- 2 Needle lift sender
- 3 Engine speed sender
- 4 Sender wheel

As with the gasoline engine, cylinder-selective misfire detection improves emission quality and engine performance. It prevents impairment of driving comfort and driving safety by misfiring and stop the fuel-air mixture from entering the exhaust gas flow unburnt.

The processes used by the systems for gasoline and diesel engines are very much alike, since their objectives are the same.

The two main differences are:

- The engine speed signal and the engine speed fluctuations are registered by a sender wheel with 4 grooves. Each groove is the TDC reference point for a cylinder.
- The cylinder is detected by the needle lift sender. It signals continuously the position of the 3rd cylinder from which the positions of the other cylinder can be calculated.



System Components (Diesel)

Charge pressure control

To optimize performance making allowance for exhaust emissions, the charge pressure also has to be regulated and monitored continuously. The charge pressure is adapted to the various driving situations so that a calculated air mass is always available for combustion.

To control the charge pressure, the diesel direct injection system control unit requires the signals generated by the engine speed sender, intake pipe temperature sender, intake manifold pressure sender, accelerator pedal position sender and altitude sender. The last is integrated in the control unit.

Using these signals, the control unit calculates the necessary nominal charge pressure and regulates the pulse duty factor for the charge pressure control solenoid valve.

The OBD II checks:

- The opening and closing functions of the charge pressure control solenoid valve by the intake manifold pressure sender
- Electrical function and signal plausibility of the charge pressure control sender and solenoid valve

Procedure:

The diesel direct injection system control unit compares the signal generated by the intake manifold pressure sender with the calculated setpoints. These setpoint are defined by means of a characteristic curve and the input signal.



Legend:

- 1 Diesel direct injection system control unit
- 2 Intake manifold pressure and intake pipe temperature
- 3 Coolant temperature sender
- 4 Engine speed sender
- 5 Accelerator position sender
- 6 Charge pressure control solenoid valve
- 7 Altitude sender
- 8 Exhaust gas turbocharger with charge pressure control valve

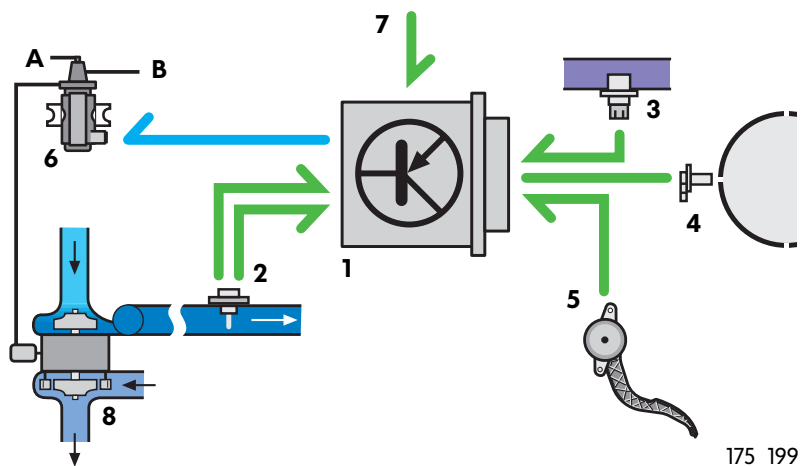

175_199

a = Vacuum

b = Atmospheric pressure

Charge pressure control solenoid valve N75

The diesel direct injection system control unit sends the calculated signals for charge pressure to the charge pressure control solenoid valve. Depending on the pulse duty factor of the signal, the solenoid valve transfers a control pressure to the charge pressure control valve at the exhaust gas turbocharger.

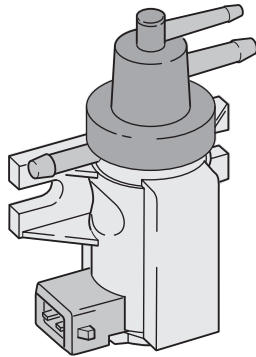

175_189

Electrical circuit

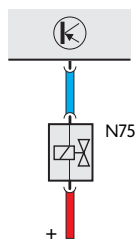

175_202

Effects of failure

The charge pressure control fails and the engine power output is reduced.

Intake manifold pressure sender G71 and intake manifold temperature sensor G72

Two senders have been combined in this component. The control unit receives signals from this combined sender containing the intake manifold pressure and temperature.

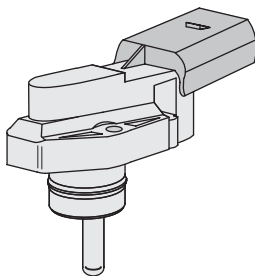

175_190

Electrical circuit

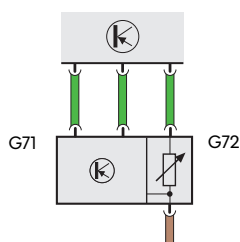

175_203

Effects of failure

G71 The charge pressure control fails and engine power output is reduced.

G72 Charge pressure is controlled by means of a substitute value.



System Components (Diesel)

Other sensors and actuators monitored

Modulating piston movement sender G149

Fuel temperature sender G81

Quantity adjuster N146

These components are located within the distributor injection pump.

The OBD II checks:

- Electrical function of modulating piston movement sender and fuel temperature sender
- Upper and lower stops of quantity adjuster

Electrical circuit

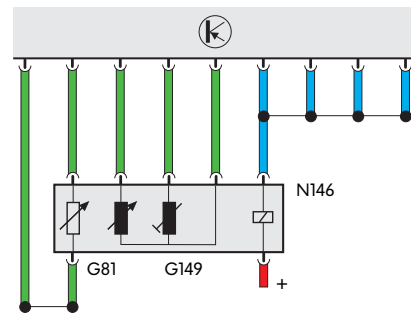

175_204

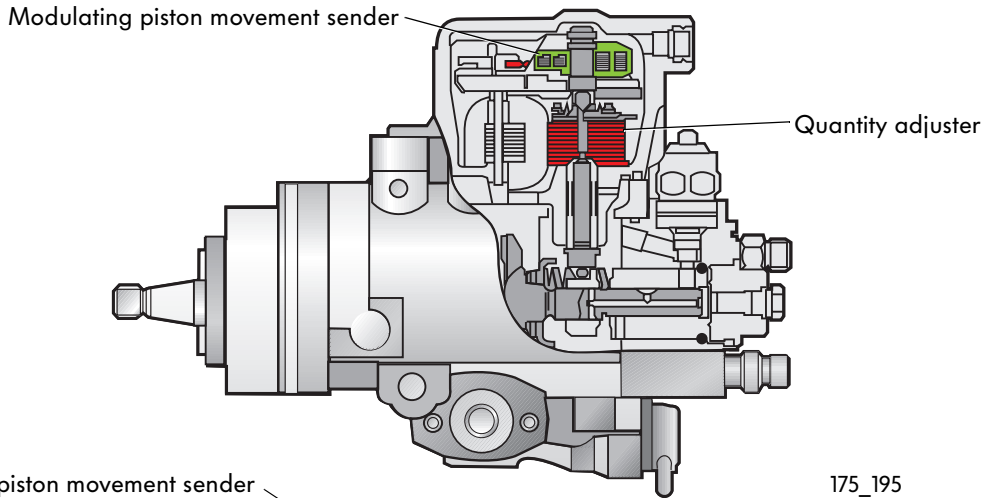

175_195

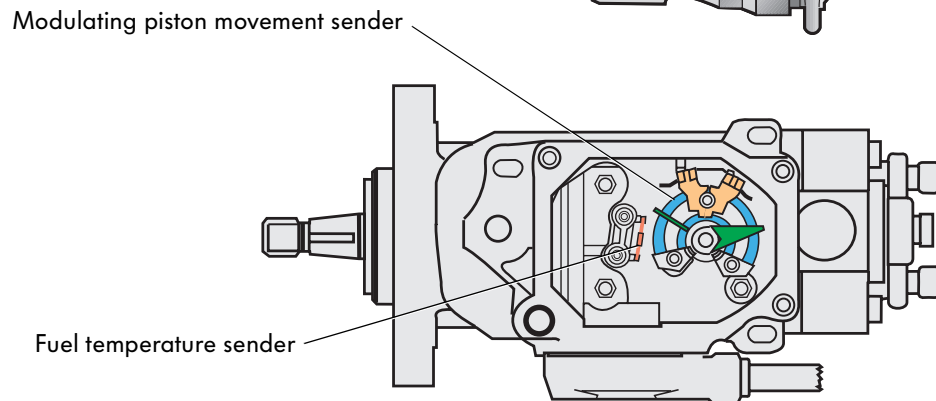

175_196

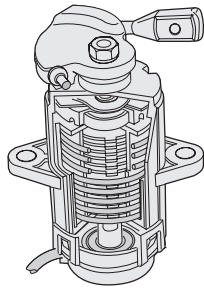

175_197

Accelerator position sender G79

This sender signals the driver input to the diesel direct injection system control unit and influences all known systems. This means that all systems require this signal directly or indirectly in order to function correctly.

The OBD II checks:

- Electrical function of sender
- Plausibility of signal

Electrical circuit

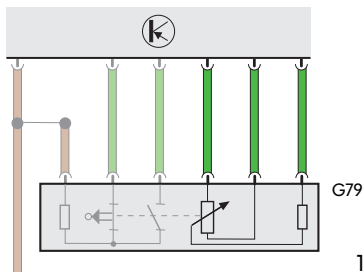

175_205

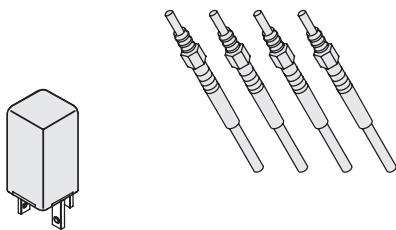

175_198

Glow plugs (engine) Q6 Glow plug relay J52

The glow phase on starting the engine and the afterglow phase up to 2500 rpm improve the engine's starting and running characteristics and reduce pollutant emission.

The OBD II checks:

- Electrical function of relay
- The function of the glow plugs by comparing them pair by pair

Electrical circuit

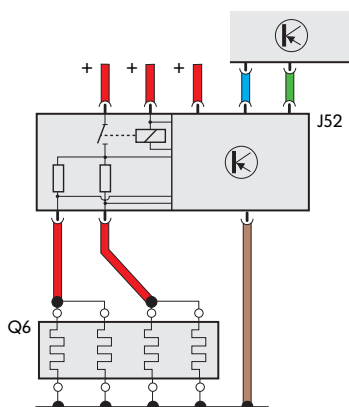

175_206



Self-Diagnosis

OBD-II (gasoline engine)

Diagnosis with the VAG 1551, VAG 1552 and VAS 5051

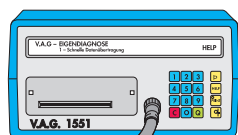

175_006



175_007

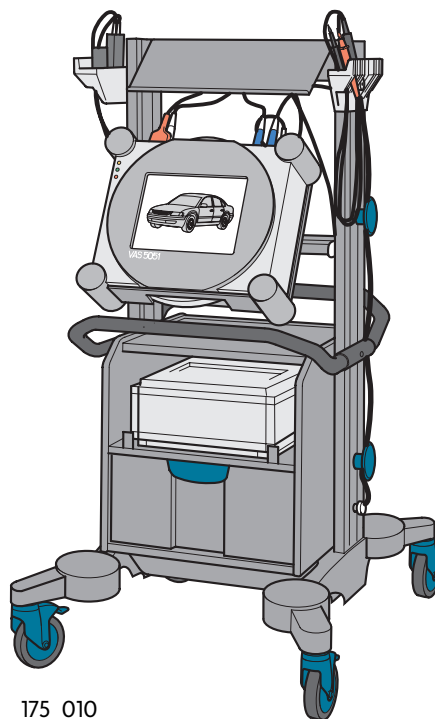

175_010



Address word

01 - Engine control unit

Functions:

- 02 - Interrogate fault memory
- 03 - Actuator diagnosis
- 04 - Basic adjustment and start short trip
- 05 - Erase fault memory
- 06 - End of output
- 07 - Encode control unit
- 08 - Read measured value block
- 15 - Readiness code read

Address word

33 - include in Scan Tool function

Functions:

- Mode 1 - diagnosis data transmitted
- Mode 2 - Operating conditions transmitted
- Mode 3 - Interrogate fault memory when self-diagnosis fault warning lamp (MIL) on
- Mode 4 - Erase fault memory
- Mode 5 - Output lambda probe signals
- Mode 6 - Interrogate measured values
- Mode 7 - Interrogate fault memory when self-diagnosis fault warning lamp (MIL) off



The VAS 5051 Diagnosis Testing and Information System can be operated in "Vehicle Self-diagnosis" mode, which is identical to the procedure which the V.A.G 1551 Faultfinding System uses.

Reading out the Readiness Codes

The Readiness Code indicates whether the system has been able to conduct all the prescribed diagnoses.

The Readiness Code can be read out with the diagnosis systems via address word "01" using function "15" or via address word "33" in Mode "1".

Procedure:

1. Enter "01" Engine electronics with ignition on



2. Acknowledge with "Q".

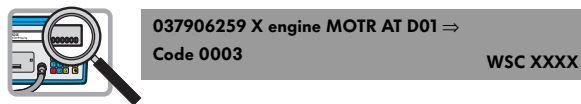

3. Press "-" button.



175_157

4. Enter "15" for Readiness Code.

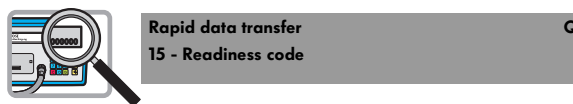

5. Acknowledge with "Q".

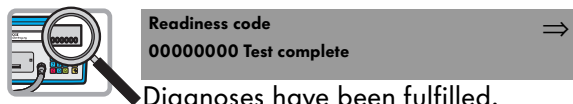

Diagnoses have been fulfilled.



Diagnoses marked "1" have still not been fulfilled or carried out.

Generating the Readiness Codes

The Readiness Code cannot be generated directly by the mechanic, e.g. by entering a key. The system sets the Readiness Code once the system has completed all the necessary diagnoses.

This happens:

- after carrying out a short trip with the diagnosis systems when using Address word "01"
- or
- after executing a FTP72-like driving cycle if only one Generic Scan Tool is available.



Self-Diagnosis

The short trip

As it is generally not possible after carrying out repair work to complete the full FTP72 cycle which the system requires in order to test all functions, a short trip must be executed in the workshop. This short trip is not a standardized driving cycle such as the FTP72 cycle, for example. It is a procedure developed in-house to generate the Readiness Code by means of defined short function tests.

The Readiness Code can only be generated with the diagnosis systems V.A.G 1551/V.A.G 1552/VAS 5051 by executing a short trip in accordance with the applicable regulations.

Function test during short trip:

- Catalytic converter
- Secondary air system
- Lambda probe
- Lambda probe heater
- Ageing of lambda probe
- Fuel supply system
- Knock sensors
- Tank ventilation system
- Leak diagnosis
- Road speed signal

Conditions for the short trip

Before commencing the short trip, the fault memory must be read and canceled after remedying the displayed fault.

Start function tests in succession.

After replacing the throttle valve control unit, it must be adapted before carrying out the test.

If a fault is detected and stored by the system and/or indicated by the self-diagnosis fault warning lamp (MIL) during the short trip, it is possible to abort the test.



Please comply with the conditions for execution of the function test.

For example:

The leak diagnosis must have been completed before warming up the engine.
The engine may not be turned off after completing the warm up.

Example of display on diagnosis systems during short trip

The mechanic has a list of Display Groups necessary for the short trip. The list also contains a guide showing the best sequence of diagnosis steps.

First initiate the rapid data transfer by entering "1" and selecting key "01" for "Engine control unit". Acknowledge each operation by pressing "Q". Then select the short trip by entering the function "04 - Basic adjustment and initiate short trip" and acknowledge again by pressing "Q".

For this diagnosis, the following display appears:

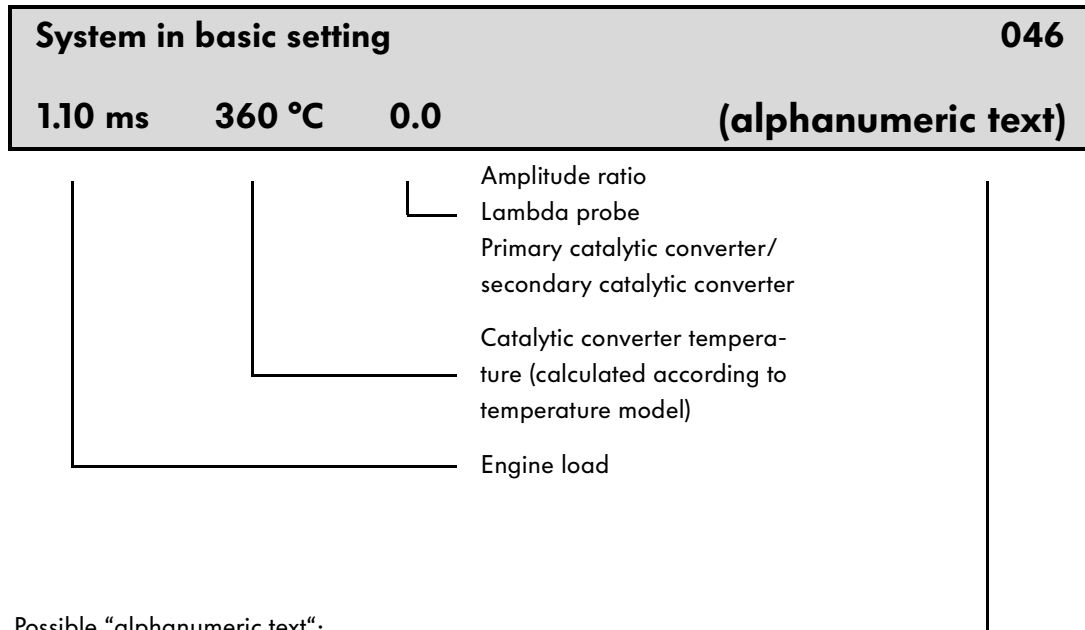

Possible "alphanumeric text":

- **Test OFF**
- **Test ON**
- **CatB1 OK** (diagnosis completed, fault free)
- **CatB1 NOK** (diagnosis completed, not fault free)



Self-Diagnosis

Summary: Readiness Code/short trip

The Readiness Code contains no information on whether faults exist in the system. It only indicates whether certain diagnoses have been completed (bit to 0) or have not been carried out yet or have been aborted (bit to 1).

If one or more faults is detected and stored, illumination of the self-diagnosis fault warning lamp (MIL) is the only visual indication to the driver or inspecting police officer.

If the engine management system detects a fault and stores a corresponding fault message to the fault memory in accordance with the applicable storage conditions, the fault can only be detected with a Scan-tool or V.A.G Tester by reading out the fault memory.

After the mechanic eliminates the fault, he clears the fault memory. This resets the Readiness Code. For the engine management system, this means that all diagnoses have to be repeated.

The short trip was created for workshops, since some diagnosis conditions are difficult to fulfill during normal vehicle operation. The short trip makes it possible for workshops to carry out diagnoses selectively under the appropriate conditions in order to recreate the Readiness Code relatively quickly.



Make sure you do not accidentally erase the fault memory or disconnect the Motronic control unit from the power supply because this will cancel the Readiness Code and you will have to create a new Readiness Code.

OBD-II (diesel)

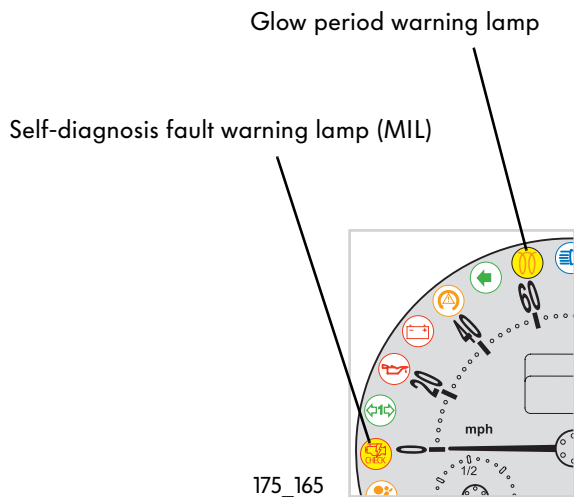

Diagnosis for diesel vehicles (TDI)

The diesel direct injection system control unit (EDC 15V) is also equipped with a fault memory. After entering a fault, this can be displayed in two ways:

- Faults which affect exhaust emission quality are indicated by the self-diagnosis fault warning lamp (MIL). These faults are recorded during the course of the OBD-II diagnosis.
- Faults which affect handling performance and driving safety are indicated by flashing of the glow period warning lamp.

If a fault is stored, it can be read out with diagnosis systems V.A.G 1551/1552 and VAS 505.

Reading out and generating the Readiness Code

In the New Beetle (U.S.A) with OBD-II (diesel), the procedure for reading out and generating the Readiness Code differs from the procedure for the gasoline engine.

The fault memory can be read out via

- Address word "01" Engine electronics,
- Function "08" Read measured value block and
- Display Group "17" Readiness Code.

Readiness Code generation does not have to be initiated by means of the diagnosis system. The Readiness code can be generated by conducting a defined test routine when the vehicle is stationary.



You can find a breakdown and procedure for generating Readiness Codes for the diesel engine in the relevant Workshop Manual.

Function Diagram (2.0-Liter Gasoline Engine)

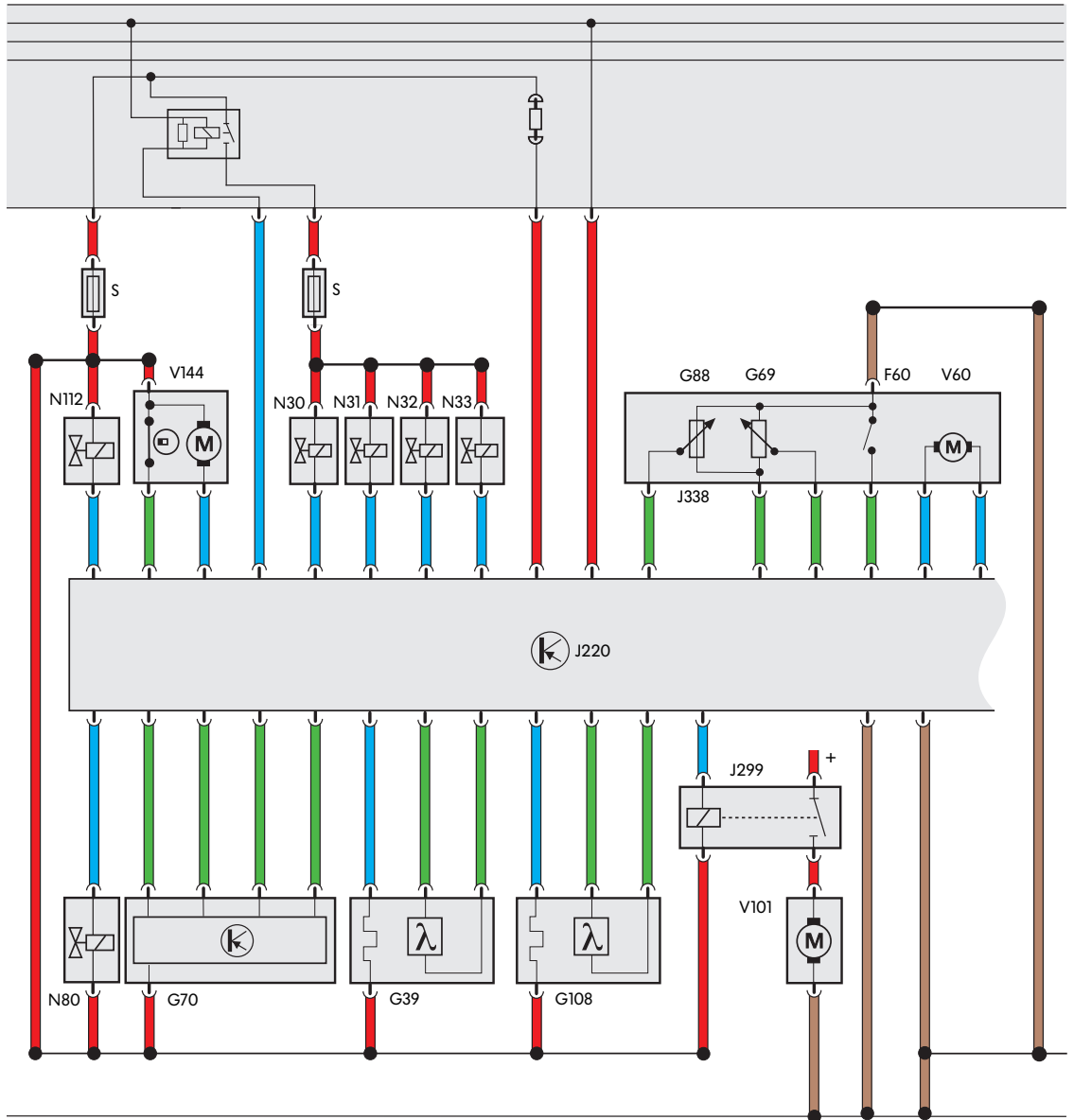

175_169a

Components

F60 Idling speed switch

G28 Engine speed sender

G39 Lambda probe I

G40 Hall sender

G61 Knock sensor I

G62 Coolant temperature sender

G66 Knock sensor II

G69 Throttle valve potentiometer

G70 Air-mass flow meter

G88 Throttle valve positioner potentiometer

G108 Lambda probe II

J220 Motronic control unit

J299 Secondary air pump relay

J338 Throttle valve control unit

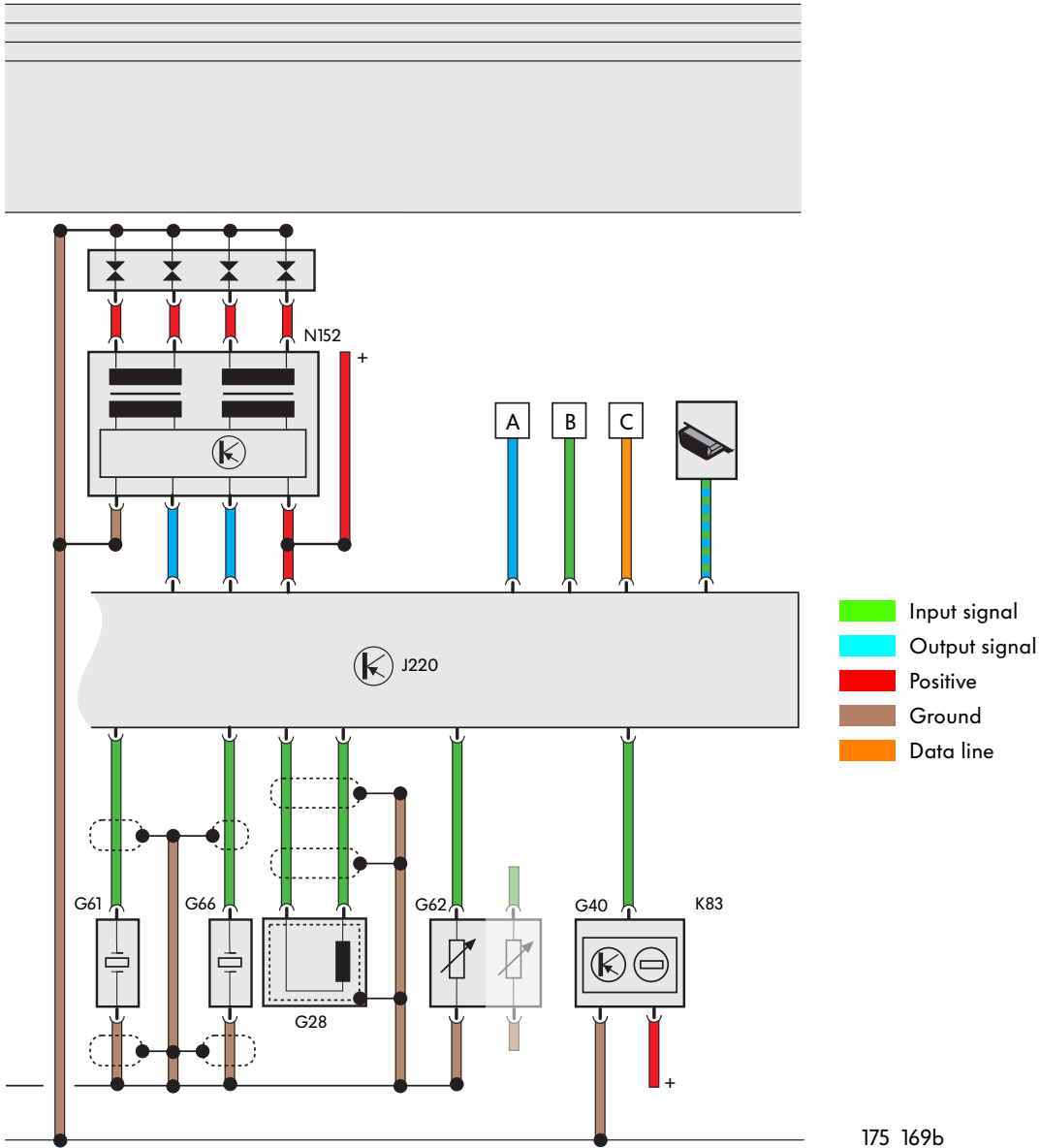

- N30 Injector, cylinder 1
- N31 Injector, cylinder 2
- N32 Injector, cylinder 3
- N33 Injector, cylinder 4
- N80 Activated charcoal filter system solenoid valve 1
- N112 Secondary air inlet valve
- N152 Ignition transformer

S Fuse

- V60 Throttle valve positioner
- V101 Secondary air pump motor
- V144 Fuel system diagnosis pump

- A Signal to self-diagnosis fault warning lamp K83 (via CAN bus from model year 2000)
- B Road speed signal from control unit with display unit in dash panel insert J285
- C CAN bus



Function Diagram (1.9-Liter TDI)

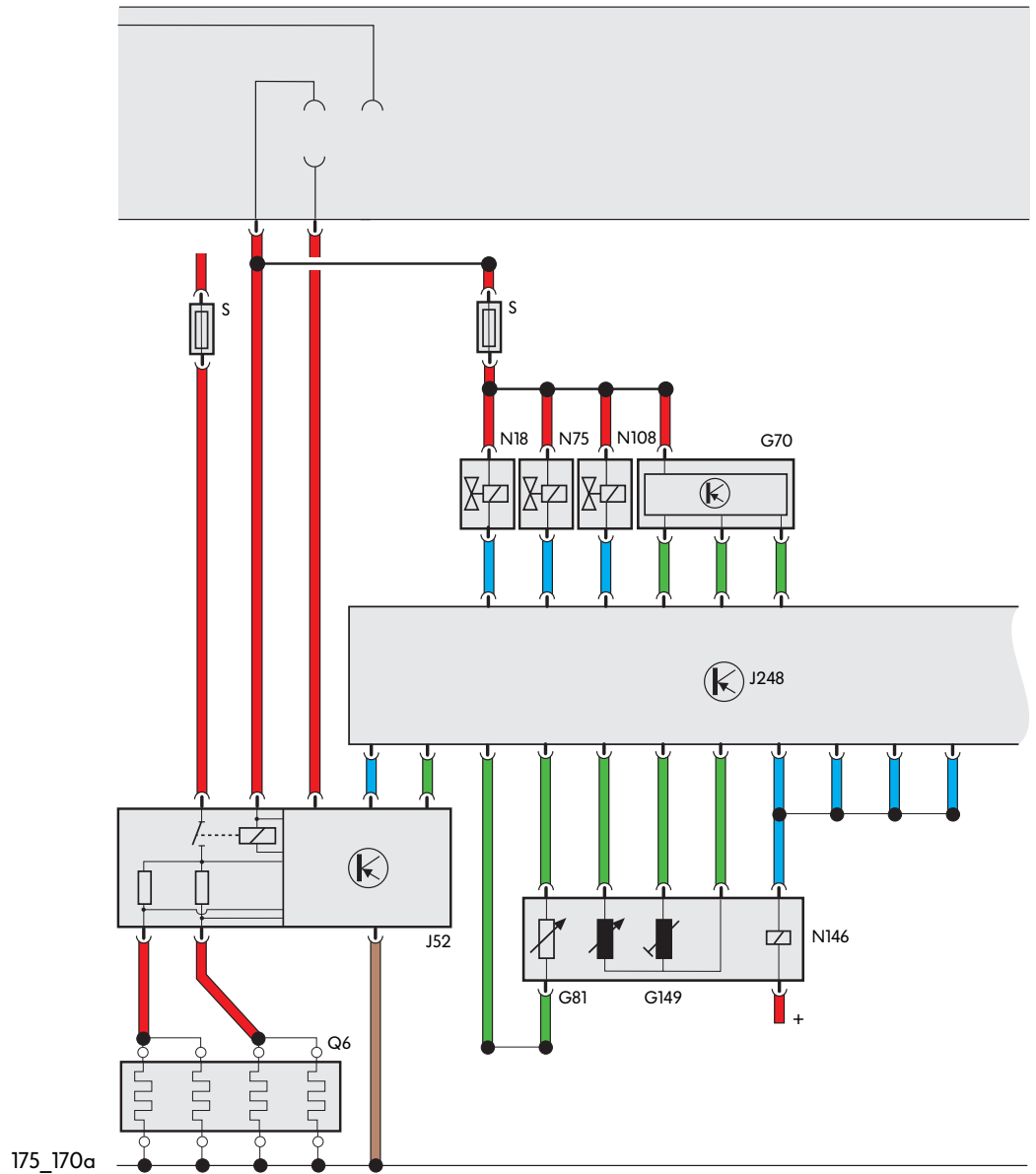

Components

- F8 Kick-down switch
- F60 Idling speed switch in G79

- G28 Engine speed sender
- G62 Coolant temperature sender
- G70 Air-mass flow meter
- G71 Intake manifold pressure sender
- G72 Intake manifold temperature sensor
- G79 Accelerator position sender

- G80 Needle lift sender
- G81 Fuel temperature sender
- G149 Modulating piston movement sender

- J52 Glow plug relay
- J248 Diesel direct injection system control unit

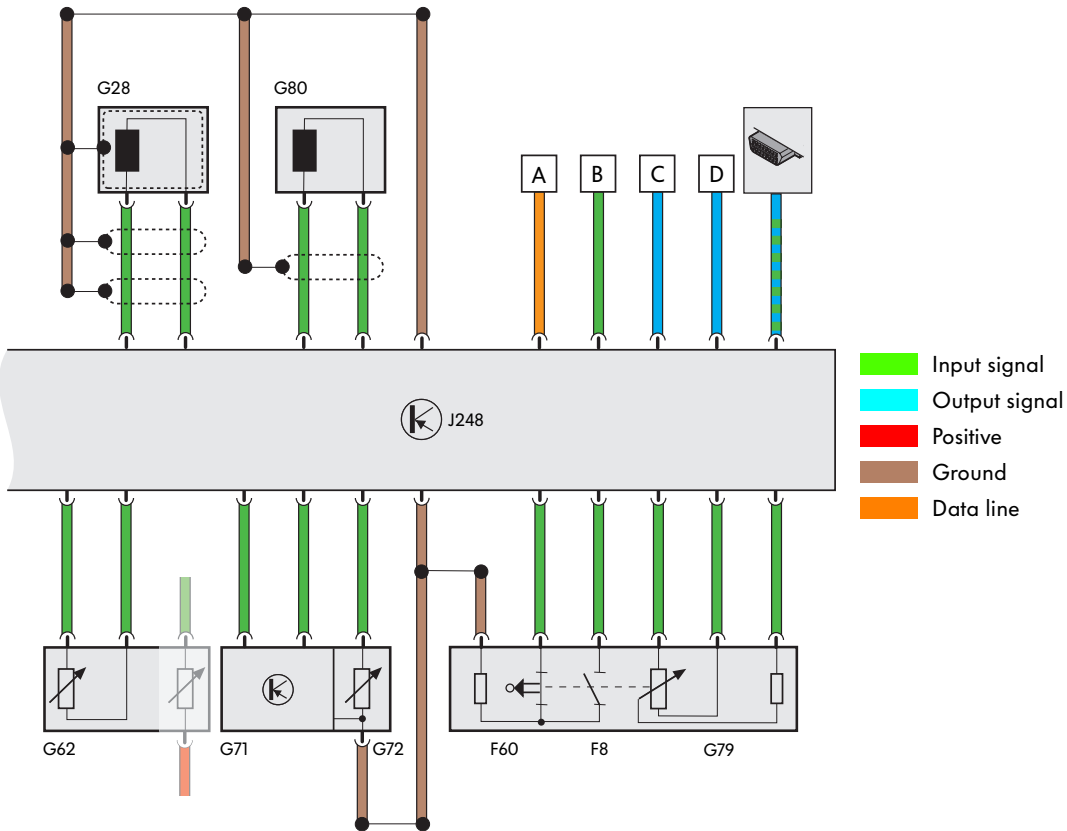

175_170b

- N18 Exhaust gas recirculation valve
- N75 Charge pressure control solenoid valve
- N108 Commencement of injection valve
- N146 Quantity adjuster
- Q6 Glow plugs (engine)
- S Fuse

- A CAN bus
- B Road speed signal from control unit with display unit in dash panel insert J285
- C Signal to glow period warning lamp K29 (via CAN bus from model year 2000)
- D Signal to self-diagnosis fault warning lamp K83 (via CAN bus from model year 2000)



Test Your Knowledge

1. What is OBD?

- a) An On-Board Diagnosis System for the monitoring engine functions and components which are relevant to exhaust emissions.
- b) An On-Board Diagnosis System that monitors wear parts such as brakes or clutch.
- c) An On-Board Diagnosis System protects the engine **only** against harmful misfiring.

2. What is a Readiness Code?

3. How is the Readiness Code generated for the gasoline engine?

- a) By entering the numeric key "15 - Readiness Code" in diagnosis system V.A.G 1551/1552.
- b) by executing an FTP72-like driving cycle.
- c) by executing a short trip with diagnosis systems V.A.G 1551/1552.

4. How does the system check whether the catalytic converter operates correctly in gasoline vehicles?



5. What statements on executing a short trip are correct?

- a) The vehicle must be grounded with a cable V.A.G 17058.
- b) The sequence of diagnosis steps and and diagnosis conditions must be observed when carrying out a short trip.
- c) The battery should always be disconnected upon completion of a short trip.
- d) The fault memory must be erased after every short trip.
- e) The short trip is initiated with the V.A.G 1551/1552 diagnosis system, address word "01" and function "04".
- f) The short trip is initiated with the V.A.G 1551/1552 diagnosis system, address word "33" and Mode "4".

**6. Where are the fuel tank purging system components fitted?
Mark the correct fitting location.**

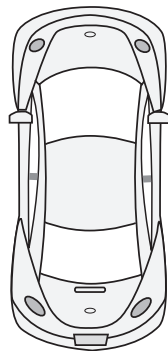

7. Describe whether and how the oxidation catalytic converter is regulated.



**Solutions:**

- 1.) a
- 2.) A numeric code which indicates that all the necessary diagnosis steps have been carried out and completed by the system.
- 3.) b, c
- 4.) The control unit evaluates the signals generated by the primary and secondary catalytic converter probes and can thereby determine whether function of the catalytic converter is functioning correctly or not.

5.) b, e

6.)

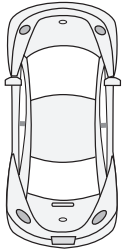

- 7.) The oxidation catalytic converter is not regulated because a lambda probe cannot be used.





For internal use only © VOLKSWAGEN AG, Wolfsburg

All rights reserved. Technical specifications subject to change without notice.

940.2809.93.20 Technical status: 03/99

 This paper is produced from
non-chlorine-bleached pulp.